

Distributed by
Raymarine

Any reference to Raytheon or RTN in this manual should be interpreted as Raymarine. The names Raytheon and RTN are owned by the Raytheon Company.

Autohelm[®]

ST 30

DEPTH
Operation and
Installation

Autohelm[®]

A **Raytheon** Company

Nautech Limited, Anchorage Park, Portsmouth
PO3 5TD, England
Telephone (0705) 693611. Fax (0705) 694642

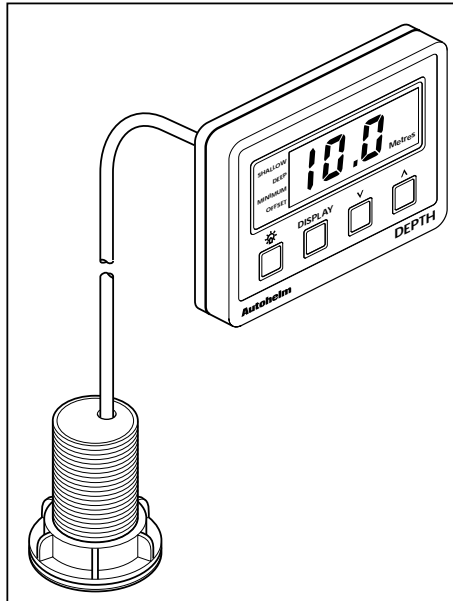

Autohelm and SeaTalk are registered Trade Marks of Nautech Limited

Autohelms policy of continuous improvement and updating may change product specifications without prior notice

Copyright Nautech 1992

Package Contents

The following items are included in the ST30 Depth package:

1. ST30 Depth instrument
2. Fixing studs (2 off)
3. Thumb nuts (2 off)
4. Fitting template
5. 1m power cable
6. Depth transducer (through hull) with 10m cable and 1/8in spade connectors
7. Instrument cover
8. Operation and installation handbook
9. Daisy-chain cable

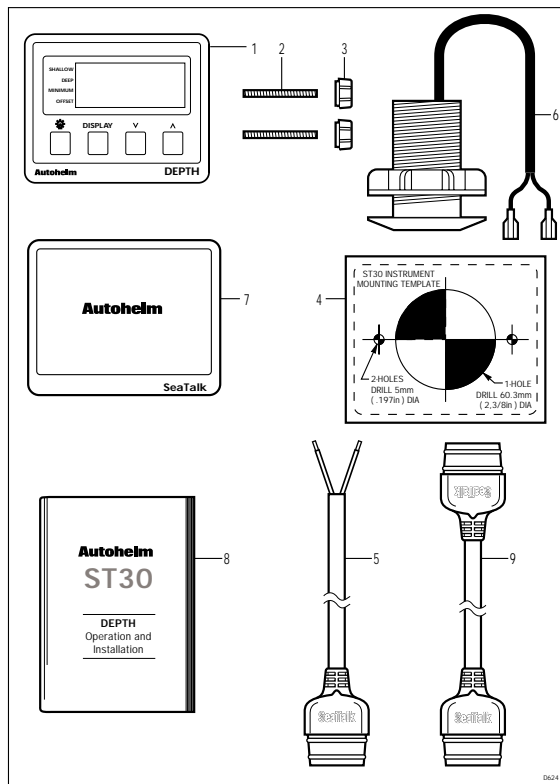

Contents

Introduction	4
Chapter 1: Control Head Installation	5
1.1 Siting	5
1.2 Mounting procedure	6
1.3 Power supply (Stand-alone operation)	7
1.4 Power supply (SeaTalk system)	7
1.5 Connection to adjacent ST30 Instruments	8
Chapter 2: Transducer Installation	9
2.1 Connection to instrument	9
2.2 Transducer type	9
2.3 Installation	10
Chapter 3: Fault Finding	12
Chapter 4: Maintenance	13
4.1 Instrument	13
4.2 Transducer	13
4.3 Cabling	13
4.4 Advice	13
Chapter 5: Operation	14
5.1 Display Key	14
5.2 Light Key	16
5.3 Alarms	16
Loss of signal	16
Chapter 6: Calibration	17
6.1 Entry to calibration	17
6.2 Depth units selection	17
6.3 Alarms and Offset	18
Shallow alarm	18
Deep alarm	19
Offset	20
Exit calibration	21
6.4 Calibration Lock/Unlock	22
Return to normal display mode	23
6.5 Master/Repeater display	23
Return to normal display mode	25
Chapter 7: General Specification	26

Introduction

Designed for above or below deck installation, the ST30 Depth can be used as a stand-alone master instrument or be set up to repeat information from the SeaTalk bus.

The ST30 Depth will display the following information:

- Water depth
- Shallow alarm
- Deep alarm
- Keel/Waterline offset
- Minimum depth
- Illumination level

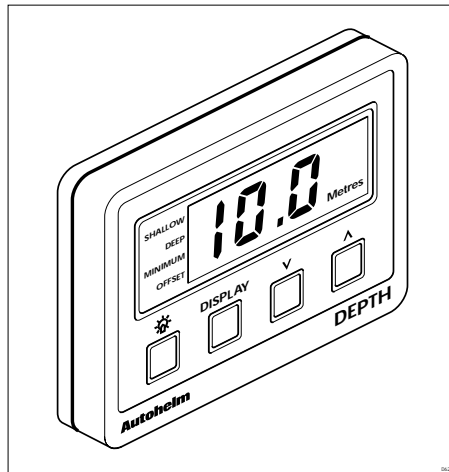

Chapter 1: Control Head Installation

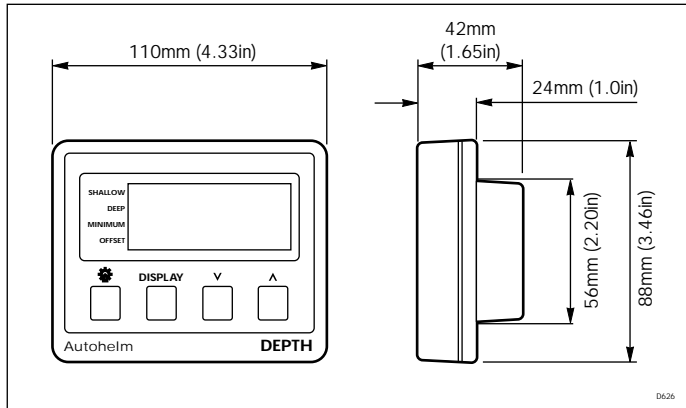

1.1 Siting

The ST30 Depth instrument may be installed above or below deck where it is:

- easily readable by the helmsman (normally viewed at eye level)
- protected from physical damage
- at least 230mm (9in) from a compass
- at least 500mm (20in) from radio receiving equipment
- accessible from behind for ease of installation and cable running

Note: To prevent the build-up of moisture the instrument breathes through the back cover. The instrument must, therefore, be mounted where the back cover is protected from direct water.

The case is fitted with a foam gasket to form a water tight seal between the instrument and the installation face.

1.2 Mounting procedure

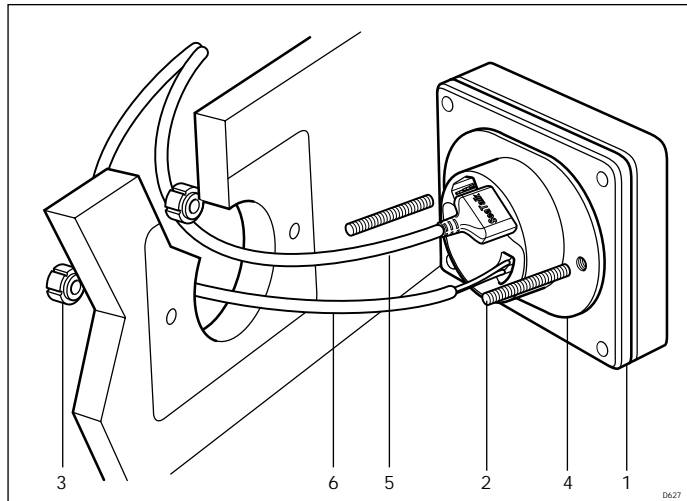

1 Instrument 2 Fixing studs 3 Thumb nuts 4 Sealing gasket

5 Power supply cable 6 Transducer cable

1. Make sure the surface to which the instrument (1) is to be mounted is smooth and flat.
2. Use the template (supplied) to mark the centres for the fixing studs (2) and the instrument connector boss.

Note: To allow protective covers to be fitted, adjacent instruments should be sited not less than 6mm (0.24in) from each other (16mm centre to centre min.).

3. Drill two 5mm (0.2in) diameter holes for the fixing studs (2).
4. Using a 60mm (2 3/8in) diameter cutter, drill a location hole for the instrument connector boss.
5. Connect the power supply and transducer cables to the back of the instrument (1). (See relevant installation sections)
6. Screw the two fixing studs (2) into the back cover of the instrument (1).
7. Install the instrument (1) and secure with the thumb nuts (3) provided.

1.3 Power supply (Stand-alone operation)

Caution: The ST30 Depth must only be connected to a 12V supply.

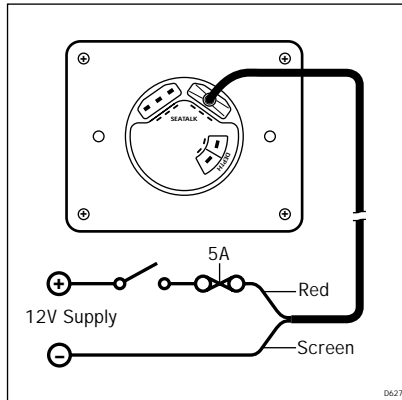

For stand-alone operation, use the 1m cable supplied with the instrument.

1. Connect the moulded power plug to either SeaTalk connection on the rear of the instrument. Run the free end back to the vessel's distribution panel.
2. Cut the power cable to length and connect the red wire to the positive 12V terminal and the screen to 0V. Protect with a 5A circuit breaker or fuse.

1.4 Power supply (SeaTalk system)

If the ST30 Depth is to be connected to a SeaTalk system, use a Standard SeaTalk Extension or Interface cable.

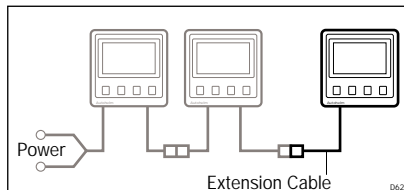

1.5 Connection to adjacent ST30 instruments

The ST30 Depth is supplied with a daisy-chain cable that allows adjacent ST30 instruments to be linked together. The daisy-chain cable supplies power to adjacent instruments and allows data to be transmitted and received via the SeaTalk bus.

The daisy-chain cable plugs into one of the SeaTalk ports on the back cover. Incorrect orientation is not possible as the ports and plugs are matched.

Chapter 2: Transducer Installation

2.1 Connection to instrument

The ST30 Depth transducer is supplied with 10m (32.5ft) of cable. This cable plugs directly into the back of the instrument.

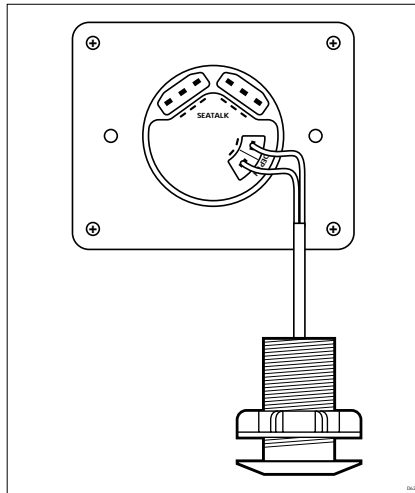

2.2 Transducer type

The ST30 Depth system is supplied (as standard) with a plastic through hull transducer. This is suitable for use with Glass Reinforced Plastic (GRP), Steel and Aluminium hulls.

Wooden hull and transom mount installations require a different type of transducer. Please refer to the following table for details.

Hull material or location	Transducer
GRP, Steel, Aluminium	Standard through hull plastic
Wood	Bronze through hull (Z118)
GRP, Steel, Aluminium	Retractable through hull (Z120)
In hull	In hull puck (Z117)

Caution: Plastic through hull transducers must not be used on vessels with wooden hulls.

2.3 Installation

All depth transducers are supplied with detailed installation and maintenance instructions. These instructions, together with the following notes, should be read thoroughly before attempting to install the transducer.

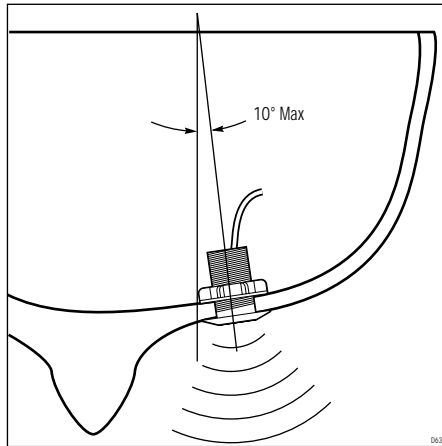

1. The ST30 Depth transducer must be within 10° of the vertical, forward, aft and athwart ships and within the shaded clear flow areas as shown.

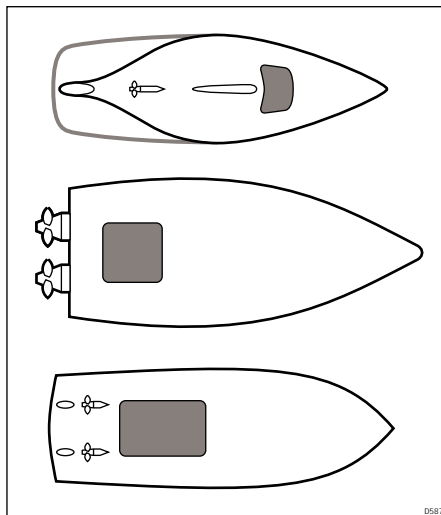

2. Run the transducer cable back to the instrument. Avoid fluorescent lights, engines, radio transmitting equipment and the speed transducer cable. The transducer cable should also be kept clear of bilge's, where possible, and be secured at regular intervals.

Note: The transducer cable must not be shortened. Shortening of this cable will affect the performance of the unit. For further information, please contact Autohelm or an authorised agent.

If the bronze through hull (Z118), in hull puck (Z117) or retractable depth (Z120) transducers are to be used, the following modification must be carried out to the transducer lead.

1. Using a pair of wire cutters, remove the moulded plug from the end of cable.
2. Strip the outer cable back 38mm (1.5in).
3. Using a pair of cable strippers, remove 10mm (3/8in) of insulation from each wire.
4. Using a suitable crimping tool, attach a 1/8in spade connector (supplied) to each of the wires.
5. Connect the wires to the instrument in accordance with the following table.

Transducer type	Colour coding (cable to unit)
Bronze through hull (Z118)	Blue & red terminal Black and screen & white terminal
In-hull puck (Z117)	As above
Retractable depth (Z120)	As above

Chapter 3: Fault Finding

All Autohelm products are, prior to packing and shipping, subject to comprehensive test and quality assurance programmes. However, if a fault arises with the ST30 Depth, the following table will help to identify the probable cause and provide the most likely cure.

Fault	Cause	Action
Instrument display blank	No supply to instrument	Check supply Check cabling and security of connectors Check circuit breaker/fuse Return ST30 Depth for repair
No depth information	Aerated water, boat wakes or propeller wash	Depth reading will return to normal once clear of disturbed water
Feet/metres display flashes continuously	Transducer cable or connector fault	Check cabling and security of transducer connector
No exchange of information between SeaTalk instruments	SeaTalk cabling or connector problem	Check security of SeaTalk connectors Remove instruments one by one to isolate faulty unit
Failure of a group of instruments in a chain	Cabling or connector problem	Check the security of the connectors between functioning and non-functioning instruments
Unable to enter calibration	Calibration locked	Refer to Calibration lock/unlock section

Note: After installation, poor performance may be experienced if the surface of the depth transducer has not been 'wetted'. Wetting can take up to 24 hours under normal conditions. The transducer can be 'wetted' prior to launch by applying a mild detergent to the external face.

Chapter 4: Maintenance

4.1 Instrument

Atmospheric conditions may cause condensation to appear on the instrument window. This will not harm the instrument and can be cleared by increasing the illumination setting to level 3.

Chemical and abrasive materials must **not** be used to clean the ST30 Depth instrument; if the instrument is dirty, clean with a soft, damp cloth.

4.2 Transducer

Refer to the Installation and Maintenance instructions supplied with the transducer.

4.3 Cabling

Examine all cables for chafing or damage to the outer shield and, where necessary, replace and re-secure.

4.4 Advice

For advice, or further information regarding installation of this product, please contact the Autohelm Product Support Department or your own National Distributor.

Chapter 5: Operation

The ST30 Depth leaves the factory set to:

- display depth in feet
- with the deep and shallow alarms switched off
- in master mode

These settings can be changed in calibration (see section 6.1).

When the ST30 Depth is switched on, the instrument will display current water depth in the units set up in calibration.



Note: The trend arrows ▲ decreasing ▼ increasing, shown in the above display, indicate whether the trend is towards deep or shallow water.

5.1 Display Key

Each press of **Display** cycles the following menu:

- **Shallow** Alarm Setting
- **Deep** Alarm Setting
- **Minimum** Depth
- **Offset** (Keel or Waterline)

A further press of **Display** will return the unit to current depth. **The display always returns to current depth after 8 seconds.**

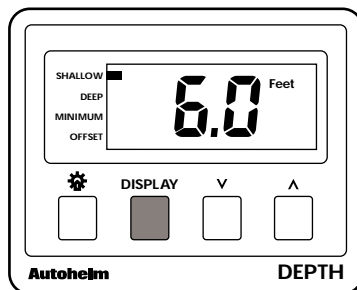

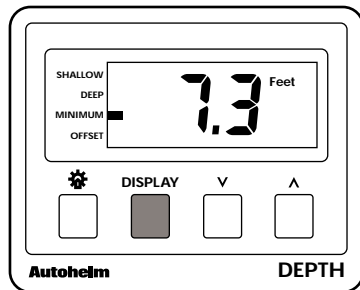
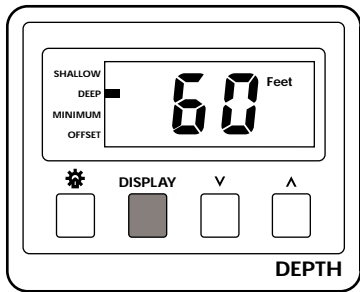

Note: The 'Minimum' depth display may be reset by pressing ^ for 1 second.

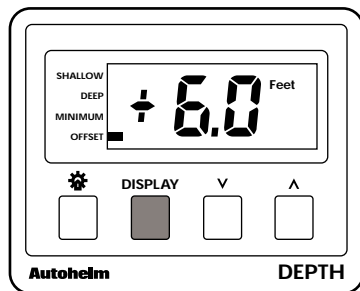

5.2 Light Key

☼ Controls the level of instrument illumination. There are 3 levels, with level 3 the brightest.

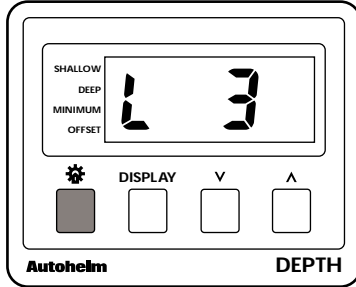

The display returns to correct depth after 8 seconds.

Note: When the ST30 Depth is used in a SeaTalk system, illumination may be adjusted from any instrument.

5.3 Alarms

The ST30 Depth is equipped with visual and audible shallow and deep water alarms.

Both of these alarms are set in calibration (see section 6.3).

Any button press will silence the 'Shallow' alarm. However, the 'Shallow' indicator will continue to flash until the depth exceeds the alarm value.

The 'Deep' alarm sounds when the 'Deep' setting is crossed either when going from shallow to deep or deep to shallow waters. Any button press will silence the alarm.

Loss of Signal

The 'feet or metres' legend flashes whenever the depth signal is lost.



Chapter 6: Calibration

6.1 Entry to calibration

The ST30 Depth can be programmed to display depth information in feet or metres. To enter calibration, press and hold **Diij** and **☄** After 2 seconds the display will show **CM**.

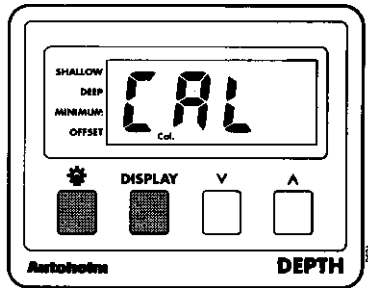

Each press of Display will cycle the unit through the calibration menu.

6.2 Depth units selection

1. Cycle **Display** until the display shows feet or metres.

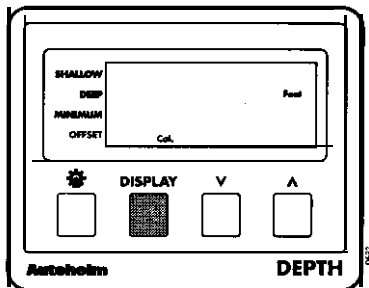

2. Select feet or metres as required using **A**.

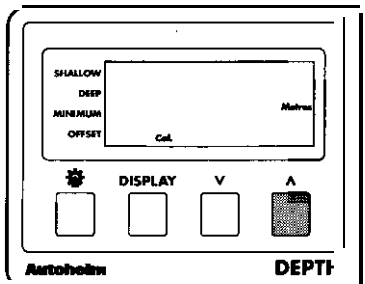

6.3 Alarms and Offset

Shallow alarm

1. Cycle Display until the 'Shallow' alarm is displayed.

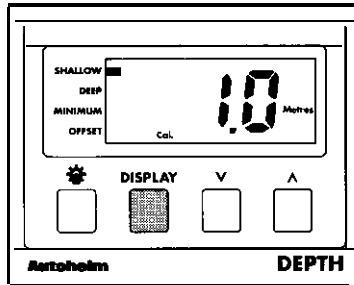

2. Press A or V to set the required depth.

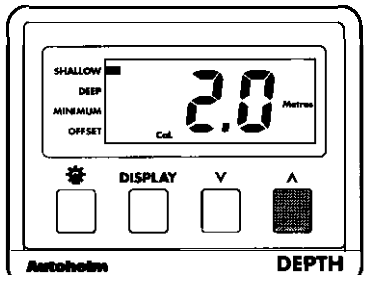

3. Shallow Alarm is enabled by pressing  When the alarm is on the 'Alarm' legend will be displayed.

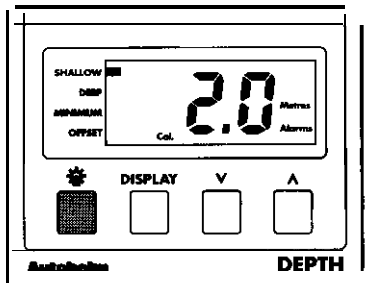

Deep alarm

1. Cycle Display until 'Deep' alarm is displayed.

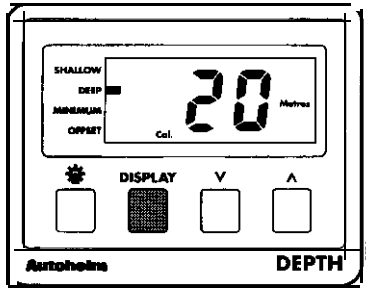

2. Press A or V to set the required depth

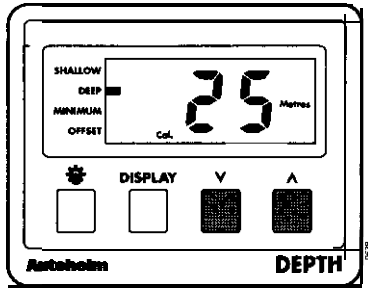

3. The 'Deep' alarm is enabled by pressing . When the alarm is on the 'Alarm' legend will be displayed.

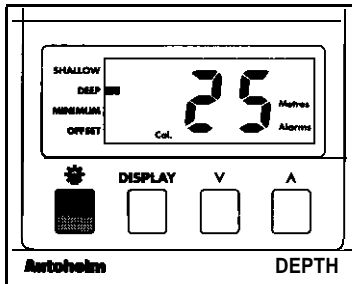

Offset

The instrument measures the water depth below the transducer. To display water depth below the keel or to the surface an offset must be set up. A negative offset is used to reduce the displayed value and give depth below the keel, a positive offset will give water depth to the surface.

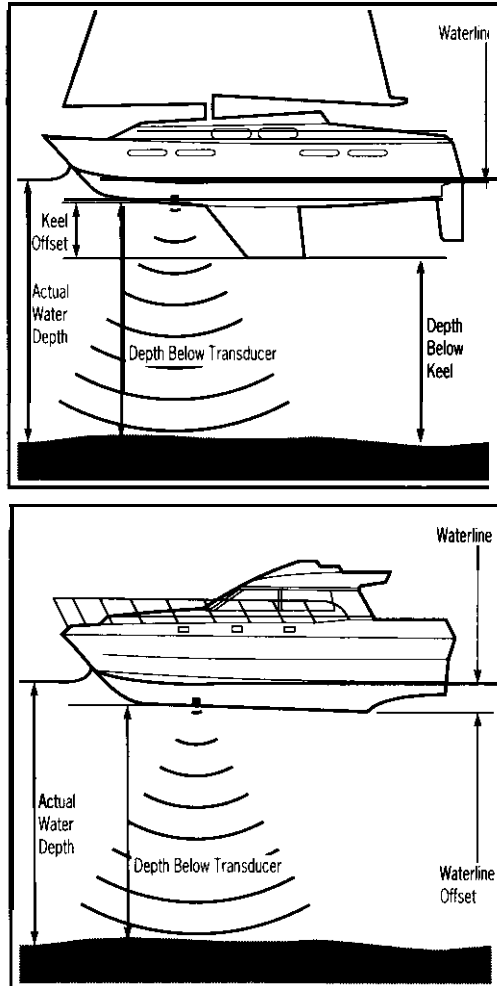

1. Press Display until 'Offset' is selected.

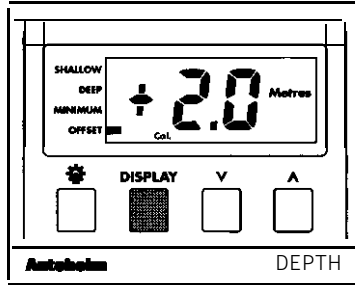

2. Press Δ or V until the required offset is displayed.

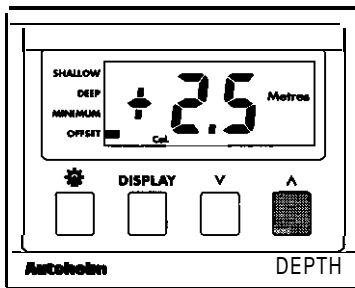

Exit calibration

To exit calibration and return to depth mode, press and hold Display and for 2 seconds.

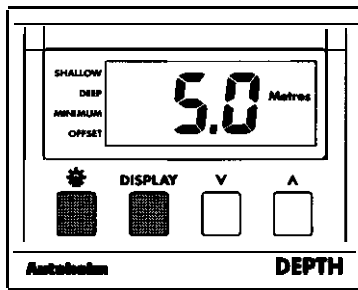

6.4 Calibration Lock/Unlock

The lock/unlock feature removes the risk of accidentally changing the set calibration values.

For security, the calibration lock/unlock feature is accessed by an extended hold down of the  and **Display** keys as follows:

1. Press and hold **Display** and  for 14 seconds until **CAL** is displayed for the second time.

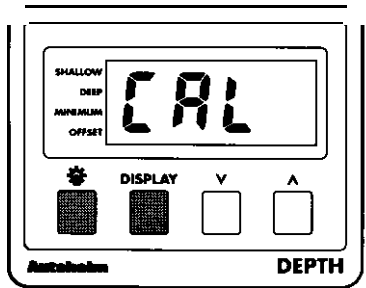

2. Press ^ and V momentarily.

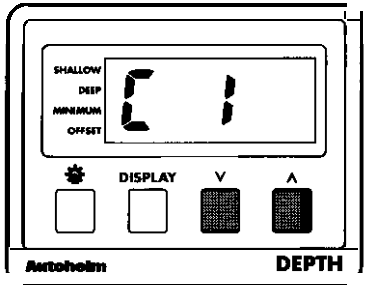

- Calibration lock/unlock is switched on or off using Δ

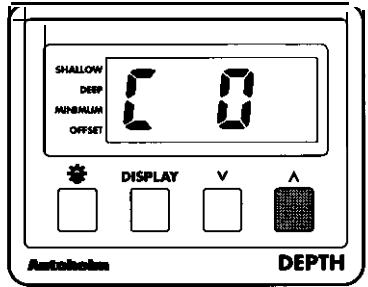

CO = Calibration locked i.e. no access

CI = Calibration unlocked i.e. normal access.

Return to normal display mode

Press and hold Display and ⚙ After 2 seconds the display returns to depth mode.

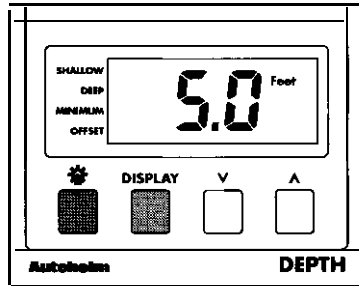

6.5 Master/Repeater display

As it leaves the factory the ST30 Depth is set to operate in Master mode. In this mode the instrument is connected to a depth transducer and transmits depth information onto the SeaTalk bus. The ST30 Depth can be set as a Repeater, repeating depth information already on the SeaTalk bus. Repeater mode is set as follows:

1. Press and hold **Display** and  until the display shows a U and a two figure number.

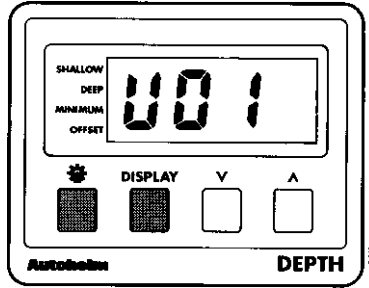

2. Press **Display** to show the current operating mode.

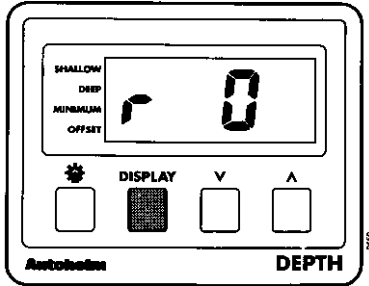

3. Press **^** to change mode.

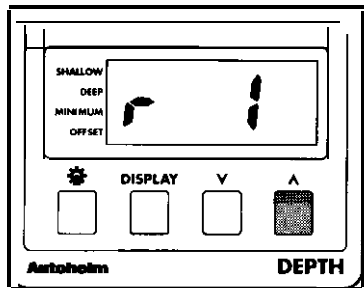

r0 = Master mode

r1 = Repeater mode

Note: When the **ST30 Depth** is set in Repeater mode access to Calibration is inhibited.

Return to normal display mode

Press and hold **Display** and  After 2 seconds the display returns to depth mode.

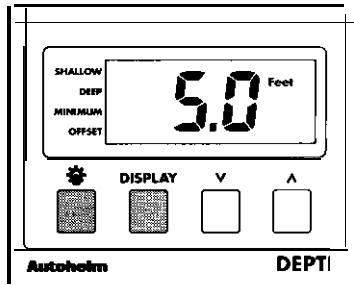

Chapter 7: General Specification

Power supply:	10 to 16V
Power consumption:	60mA (without illumination) 100mA (illuminated)
Transmitted power (RMS):	50W
Operating frequency:	200kHz
Temperature range:	0 to 70 deg° C
Shallow alarm:	1 to 10m (0.1 increments) 3 to 33ft (1ft increments)
Deep alarm:	3 to 120m (1m increments) 10 to 400ft (10ft increments)
Offset:	-4 to +4m (0.1 increments) -9.9 to +9.9ft (0.1 increments)
Minimum depth function:	Reset on power-up
Units:	Software programmable selection in metres (m) or feet (ft) – stored in EPROM
Calibration lock/unlock:	Software programmable
Repeater capability:	Software programmable

Autohelm[®]

A **Raytheon** Company

Nautech Limited, Anchorage Park, Portsmouth
PO3 5TD, England
Telephone (0705) 693611. Fax (0705) 694642

Autohelm[®]

A **Raytheon** Company

Nautech Limited, Anchorage Park, Portsmouth
PO3 5TD, England
Telephone (0705) 693611. Fax (0705) 694642