

Distributed by
Raymarine

Any reference to Raytheon or RTN in this manual should be interpreted as Raymarine. The names Raytheon and RTN are owned by the Raytheon Company.

Autohelm[®]

ST 30

SPEED
Operation and
Installation

Autohelm[®]

A **Raytheon** Company

Nautech Limited, Anchorage Park, Portsmouth
PO3 5TD, England
Telephone (0705) 693611. Fax (0705) 694642

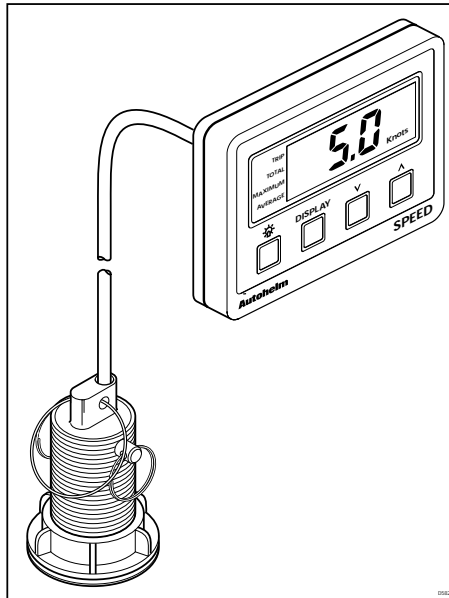

Autohelm and SeaTalk are registered Trade Marks of Nautech Limited

Autohelms policy of continuous improvement and updating may change product specifications without prior notice

Copyright Nautech 1992

Package Contents

The following items are included in the ST30 Speed package:

1. ST30 Speed instrument
2. Fixing studs (2 off)
3. Thumb nuts (2 off)
4. Fitting template
5. 1m power cable
6. Paddle transducer (through hull) with 10m cable and 1/8in spade connectors (0 to 32 knots)
7. Instrument cover
8. Operation and installation handbook
9. High speed paddlewheel (2 to 45 knots)
10. Daisy-chain cable

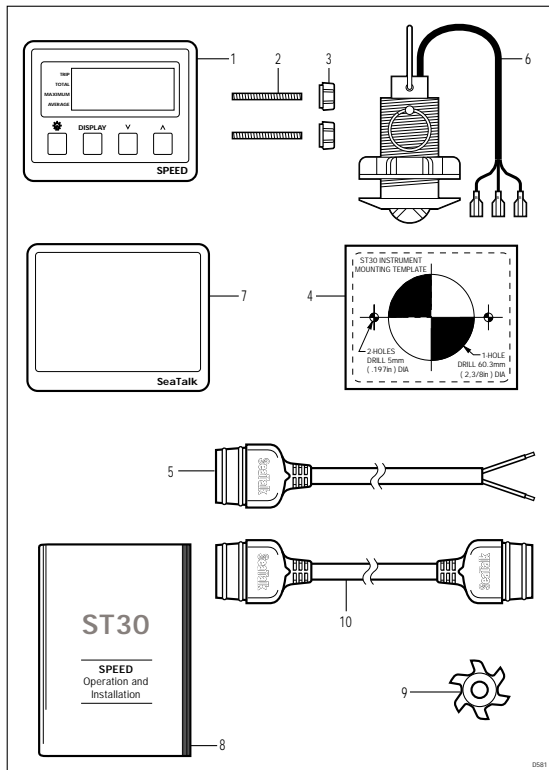

Contents

Introduction	4
Chapter 1: Control Head Installation	5
1.1 Siting	5
1.2 Mounting procedure	6
1.3 Power supply (Stand-alone operation)	7
1.4 Power supply (SeaTalk operation)	7
1.5 Connection to adjacent ST30 instruments	8
Chapter 2: Transducer Installation	9
2.1 Connection to instrument	9
2.2 Transducer type	10
2.3 Paddlewheel replacement	10
2.4 Installation	12
Speed transducer (through hull)	12
2.5 Cabling	13
Chapter 3: Fault Finding	14
Chapter 4: Maintenance	15
4.1 Instrument	15
4.2 Transducer	15
4.3 Cabling	15
4.4 Advice	15
Chapter 5: Operation	16
5.1 Display Key	16
Trip Distance display	17
Total Distance display	17
Maximum Speed display	18
Average Speed display	18
5.2 Light Key	19
Chapter 6: Calibration	20
6.1 Normal Calibration	20
Speed units selection (knots/mph)	20
Logs units selection (nm/miles)	21
Exit calibration	22
Log calibration	22
Enter calibration factor (CF)	23
Exit calibration	24
6.2 Calibration Lock/Unlock	24
Return to normal display	25
6.3 Master/Repeater display	26
Return to normal display	27
Chapter 7: General Specification	28

Introduction

Designed for above or below deck installation, the ST30 Speed can be used as a stand-alone master instrument or can be set to repeat speed information from the SeaTalk bus.

The ST30 Speed will display the following information:

- Boat speed
- Log
- Trip
- Maximum speed
- Average speed
- Illumination level

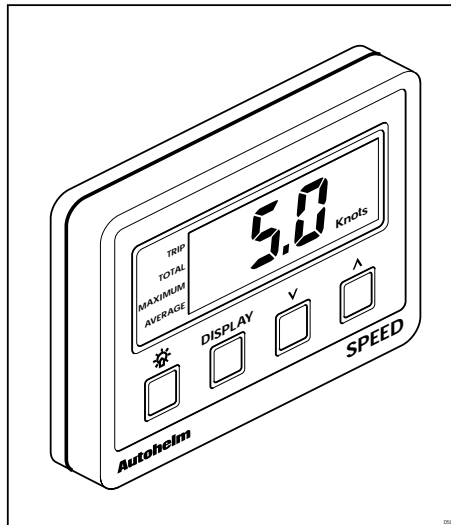

Chapter 1: Control Head Installation

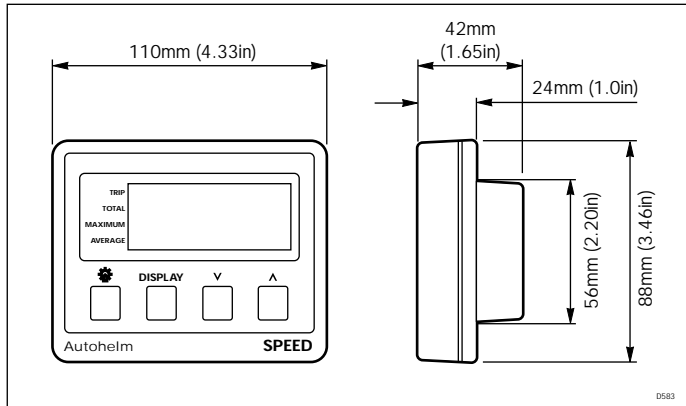

1.1 Siting

The ST30 Speed may be installed above or below deck where it is:

- easily readable by the helmsman (normally viewed at eye level)
- protected from physical damage
- at least 230mm (9in) from a compass
- at least 500mm (20in) from radio receiving equipment
- accessible from behind for ease of installation and cable running

Note: To prevent the build-up of moisture the instrument breathes through the back cover. For this reason the instrument must be mounted where the back cover is protected from direct water.

The rear case is fitted with a foam gasket to form a water-tight seal between the instrument and the installation face.

1.2 Mounting procedure

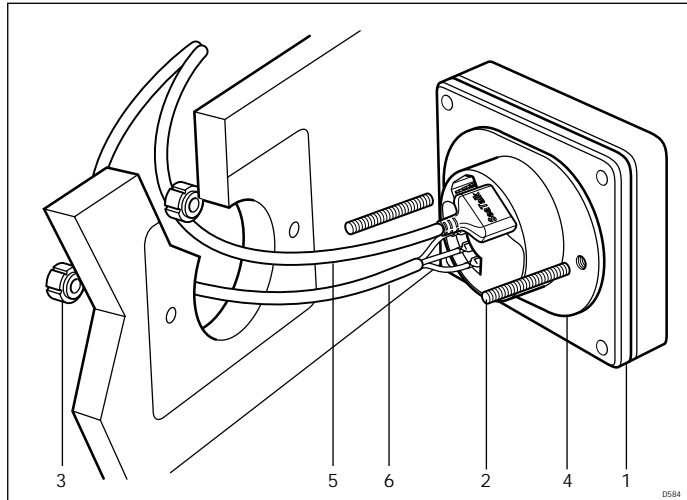

1 Instrument 2 Fixing studs 3 Thumb nuts 4 Sealing gasket
5 Power supply cable 6 Transducer cable

1. Make sure the surface to which the instrument (1) is to be mounted is smooth and flat.
2. Use the template (supplied) to mark the centres for the two fixing holes and the instrument connector boss.

Note: To allow protective covers to be fitted, adjacent instruments should be sited not less than 6mm (0.24in) from each other (116mm centre to centre min.).

3. Drill two 5mm (0.2in) diameter holes for the fixing studs (2).
4. Using a 60mm (2 3/8in) diameter cutter, drill a location hole for the instrument connector boss.
5. Connect the power supply and transducer cables to the back of the instrument (1) (see relevant installation sections).
6. Screw the two fixing studs (2) into the back of the instrument (1).
7. Install the instrument (1) in the chosen location and secure with the thumb nuts (3) provided.

1.3 Power supply (Stand-alone operation)

Caution: The ST30 Speed must only be connected to a 12V supply.

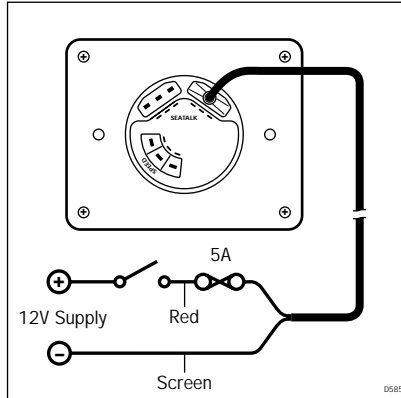

For stand-alone operation, use the 1 metre cable supplied with the instrument.

1. Connect the moulded power supply plug to either SeaTalk connection on the rear of the instrument and run the free end back to the vessel's distribution panel.
2. Cut the power cable to length and connect the red wire to the positive 12V terminal and the screen to 0V. Protect with a 5A circuit breaker or fuse.

1.4 Power supply (SeaTalk operation)

If the ST30 Speed is to be connected to an existing SeaTalk system use a Standard SeaTalk Extension or Interface cable.

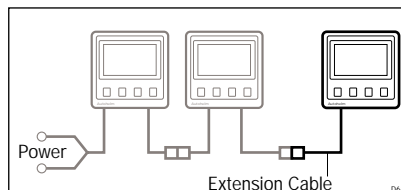

1.5 Connection to adjacent ST30 instruments

The ST30 Speed is supplied with a daisy-chain cable that allows adjacent ST30 instruments to be linked together. The daisy-chain cable supplies power to adjacent instruments and allows data to be transmitted and received via the SeaTalk bus.

The daisy-chain cable plugs into one of the SeaTalk ports on the back cover.

Chapter 2: Transducer Installation

2.1 Connection to instrument

The transducer is supplied with 10m (32.5ft) of cable that plugs directly into the back of the instrument.

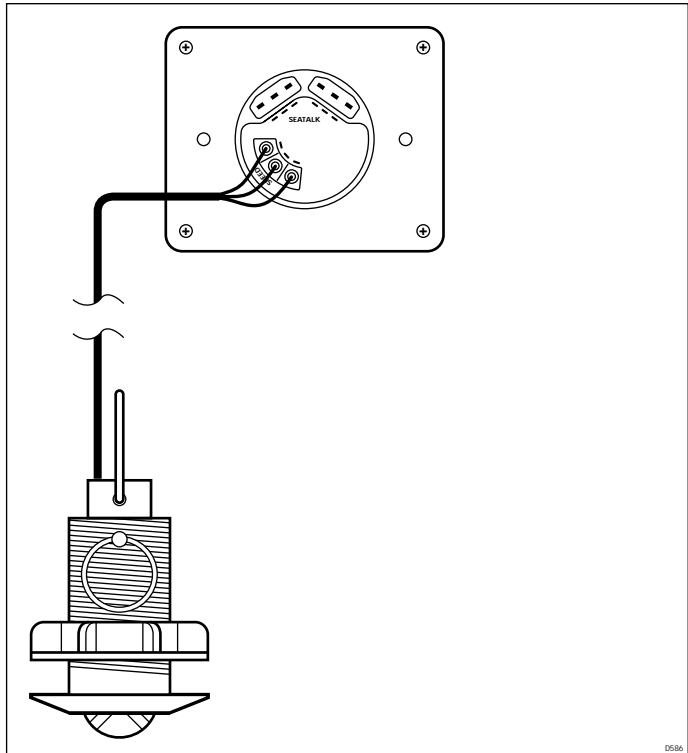

2.2 Transducer type

The ST30 Speed system is supplied, as standard, with a plastic through hull transducer. This is suitable for use with Glass Reinforced Plastic (GRP), Steel and Aluminium hulls at speeds up to 32 knots.

Wooden hull and transom mount installations require a different type of transducer. Please refer to the following table for details.

Hull material or location	Boat speed (max)	Transducer type
GRP, Steel, Aluminium	32kts	Standard through hull
GRP, Steel, Aluminium	45kts	Standard with high speed paddle
Wood	45kts	Bronze (Z116)
Transom	60kts	Transom mount with bracket (Z119)

Caution: Plastic through hull transducers must not be used on vessel's with wooden hulls.

Note: The ST30 speed transducers are fitted with standard paddlewheels designed for speed up to 32 knots. For vessel's that will exceed this speed, please refer to section 2.3 which contains instructions on how to fit the high speed paddlewheel (supplied).

2.3 Paddlewheel replacement

If the high speed paddlewheel (supplied) is to be fitted, or the existing paddlewheel to be replaced, proceed as follows:

1. Remove the retaining rings (1) and pin (6) from the speed transducer (3).
2. Withdraw the speed transducer (3) from the through hull fitting (4).
3. If replacing a worn paddlewheel and if the vessel is still in the water, replace the speed transducer (3) with the plug (5).
4. Remove the pin (6) that retains the paddlewheel (7) in the speed transducer (3). This is a simple press fit into the transducer housing.

5. Fit the high speed/replacement paddlewheel (7) to the speed transducer (3) and retain with the pin (6).

Note: The paddlewheel is correctly orientated when the working surfaces of each paddle are facing forwards.

6. Assemble the speed transducer (3) to the through hull fitting (4) and secure with retaining rings (1) and pin (2).

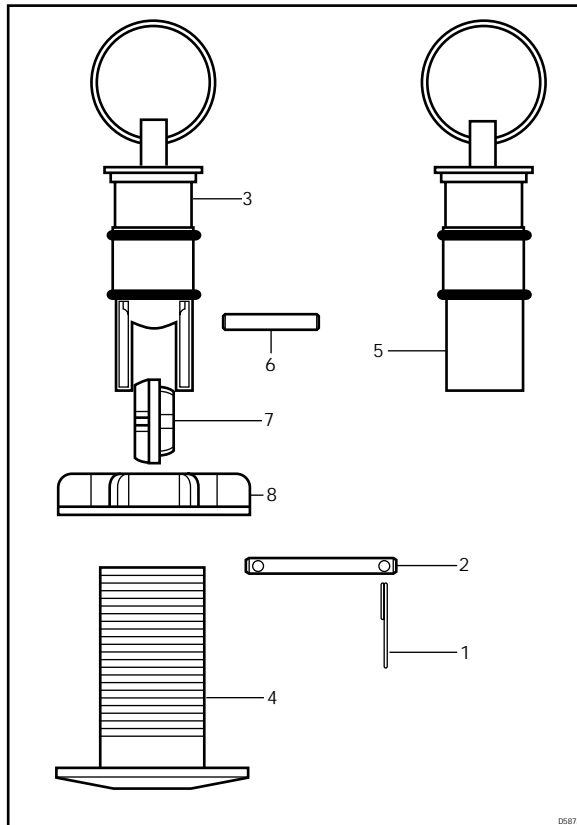

2.4 Installation

All speed transducers are supplied with detailed installation and maintenance instructions. These instructions, together with the following notes, should be read thoroughly before attempting to install the transducer.

Speed transducer (through hull)

For accurate speed readings, locate the speed transducer in the shaded 'clear flow' areas as shown.

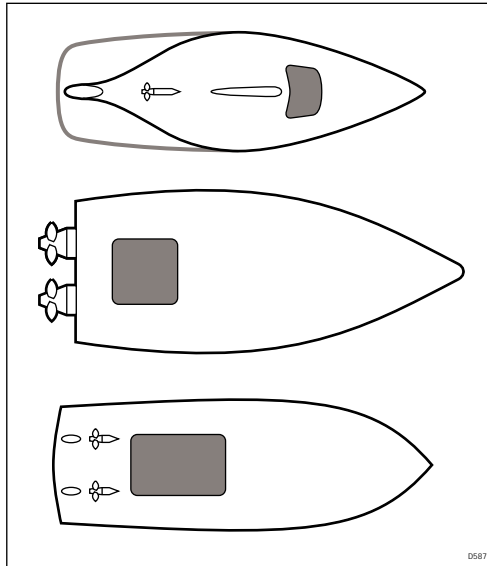

The transducer should also be:

- ahead of propellers (10% W.L. length minimum)
- at least 150mm (6in) from the keel (with sailing yachts siting should be forward of the keel).
- near the centreline of the vessel
- clear of other through hull fittings or projections
- have sufficient clearance inside the hull to allow the nut to be fitted
- have 100mm (4in) clearance above the through hull fitting for with-drawal

2.5 Cabling

Run the transducer cable back to the instrument. Avoid fluorescent lights, engines and radio transmitting equipment. The transducer cable should also be kept clear of bilge's, where possible, and be secured at regular intervals.

Note: The transducer cable can, if required, be shortened. However, new 1/8in spade connectors must be crimped to the shortened cable.

If the bronze through hull (Z116) or the transom mount (Z119) transducers are to be used, the following modification must be carried out on the transducer lead.

1. Using a pair of wire cutters, remove the moulded plug from the end of cable.
2. Strip the outer cable back 38mm (1.5in).
3. Using a pair of cable strippers, remove 10mm (3/8in) of insulation from each wire.
4. Using a suitable crimping tool, attach a 1/8in spade connector (supplied) to each of the wires.
5. Connect the wires to the instrument in accordance with the following table.

Transducer type	Colour coding (cable to unit)
Bronze through hull (Z116)	Brown and white Ø cut back Green Ø green terminal Screen Ø white terminal Red Ø red terminal
Transom mount (Z119)	As above

Chapter 3: Fault Finding

All Autohelm products are, prior to packing and shipping, subject to comprehensive test and quality assurance programmes. However, if a fault arises with the ST30 Speed, the following table will help to identify the probable cause and provide the most likely cure.

Fault	Cause	Action
Instrument display blank	No supply to instrument	Check supply Check cabling and security of connectors Check circuit breaker Return ST30 Speed for repair
No speed information	Transducer cabling problem or fouled	Clean paddlewheel
No exchange of information between SeaTalk instruments	SeaTalk cabling or connector problem	Check security of SeaTalk connectors Remove instruments one by one to isolate faulty unit
Failure of a group of instruments in a chain	Cabling or connector problem	Check the security of the connectors between functioning and non-functioning instruments
Unable to enter calibration	Calibration locked	Refer to Calibration lock/unlock section

Chapter 4: Maintenance

4.1 Instrument

Certain conditions may cause condensation to appear on the instrument window. This will not harm the instrument and can be cleared by increasing the illumination setting to level 3.

Chemical and abrasive materials must **not** be used to clean the ST30 Speed instrument; if the instrument is dirty, clean with a soft, damp cloth.

4.2 Transducer

Refer to the Installation and Maintenance instructions supplied with the transducer.

4.3 Cabling

Examine all cables for chafing or damage to the outer shield and, where necessary, replace and re-secure.

4.4 Advice

For advice, or further information regarding installation of this product, please contact the Autohelm Product Support Department or your own National Distributor.

Chapter 5: Operation

The ST30 Speed leaves the factory set to:

- display speed in knots
- display distance in nm
- Master mode

These settings can be changed in calibration.

When the ST30 Speed is powered on the instrument displays 'Boat Speed'.

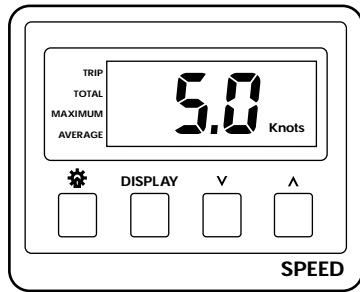

5.1 Display Key

Each press of **Display** cycles the following menu:

- **Trip** distance
- **Total** distance
- **Maximum** speed
- **Average** speed

A further press will return the display to the current boat speed.

The maximum speed and average speed displays will automatically return to current 'Boat Speed' after 8 seconds.

Trip Distance display

1. Press **Display** to select 'Trip Distance'.

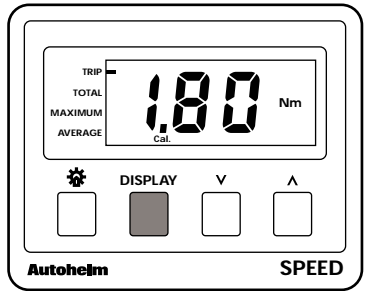

2. To reset Trip Distance to zero, press and hold **^** for 3 seconds. The trip display will flash on and off before resetting to zero.

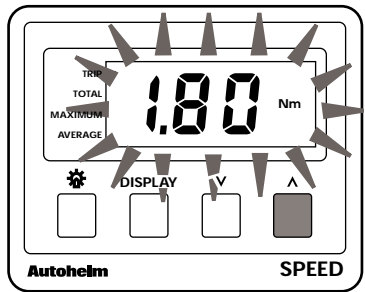

Total Distance display

Press **Display** to select 'Total Distance'. The Total Distance display shows the total distance covered in nm or miles.

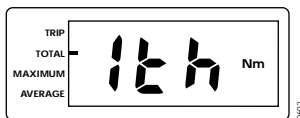

Note: If this distance exceeds 1000nm/miles, it will be displayed in thousands, hundreds and tens (e.g., 1th, 510).

Maximum Speed display

1. Press **Display** to select 'Maximum Speed'. This display shows the maximum speed achieved in knots or mph.

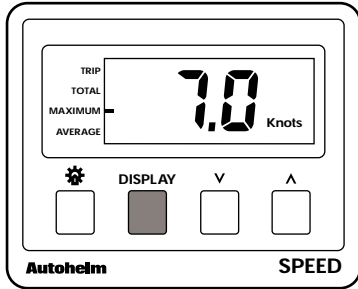

2. The maximum speed display is reset by pressing ^ for one second.

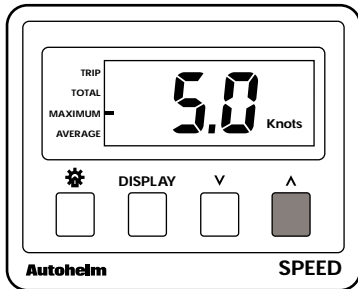

Average Speed display

1. Press **Display** to select 'Average Speed'. This display shows the average speed in knots or mph.

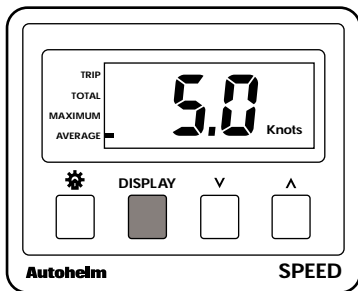

- The Average Speed display may be reset by pressing \wedge for one second.

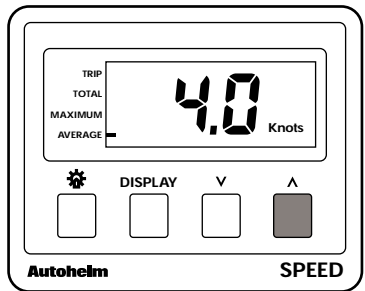

5.2 Light Key

The  key controls the level of instrument illumination. There are 3 levels, with level 3 the brightest.

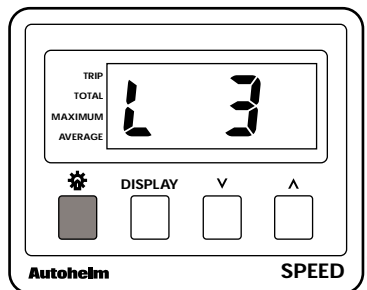

Note: When the ST30 Speed is used in a SeaTalk system, the level may be adjusted from any instrument.

Chapter 6: Calibration

6.1 Normal Calibration

The ST30 Speed can be programmed to display speed information in knots or mph and distance in nm or miles.

To select the calibration menu, press and hold **Display** and . After 2 seconds the display will show **CAL**.

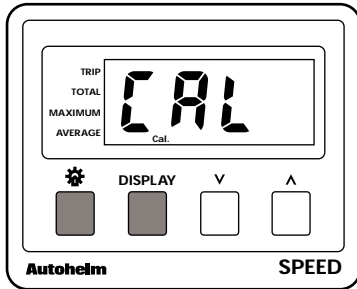

Each press of **Display** will cycle through the calibration menu.

Speed units selection (knots/mph)

1. Press **Display** for selection of knots or mph.

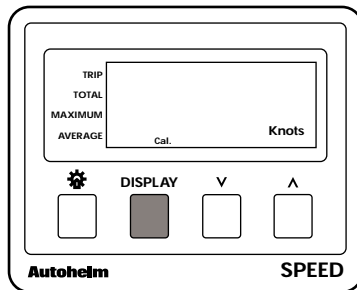

- Press \wedge to change the selection.

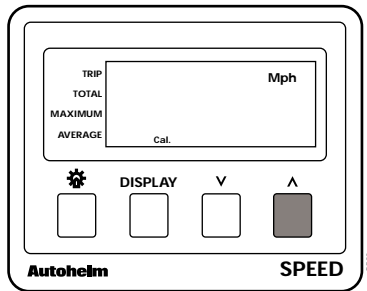

Log units selection (nm/miles)

- When Units Selection (nm/miles) is cycled the display shows nm or miles.

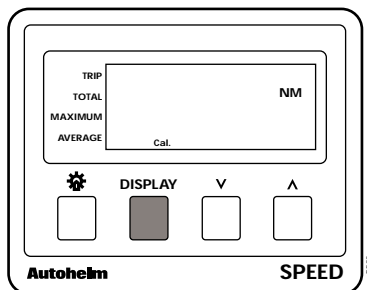

- Press \wedge to change between nm and miles.

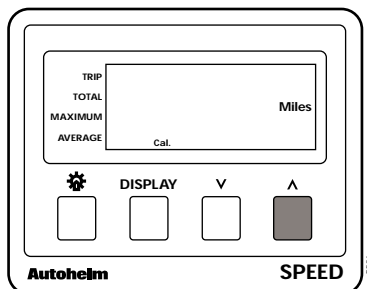

Exit calibration

Press **Display** and  for 2 seconds.

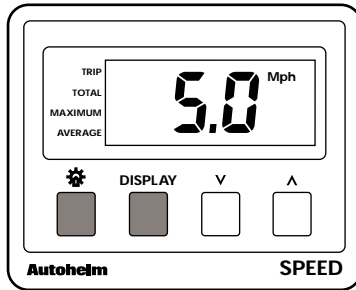

Log calibration

The ST30 Speed should not be used for navigational purposes until the transducer paddlewheel has been calibrated to suit the characteristics of the vessel.

This is a simple operation and is carried out as follows:

1. Choose two charted points that are approximately 1nm apart.

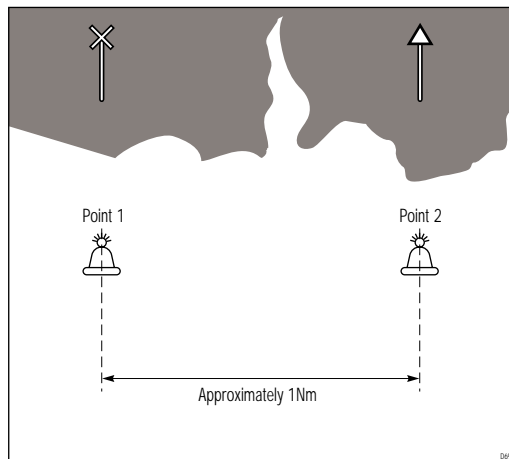

2. Choosing a time when the tidal flow is at a minimum, go from point 1 to point 2 and record the ST30 Speed trip distance.
3. Go from point 2 to point 1 and record the trip distance.
4. Add the two distances together and divide by two to obtain an average distance.

5. Measure the distance between the two points on a chart.
6. The correction factor (CF) can now be calculated.

$$CF = \frac{\text{Charted Distance}}{\text{Average Distance}}$$

Enter calibration factor (CF)

1. Press Display and  for 2 seconds until CAL is displayed.

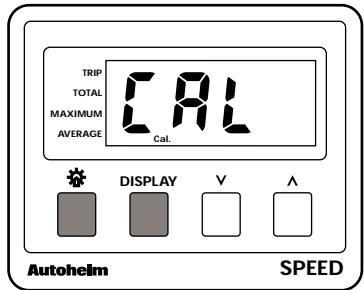

2. Press **Display** until **Log Cal** is shown in the window.

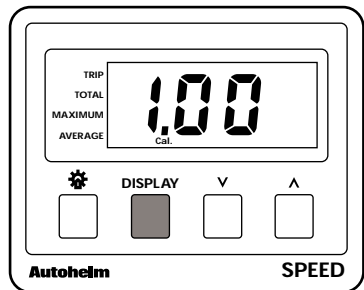

3. Press **^** or **V** to enter the calculated correction factor.

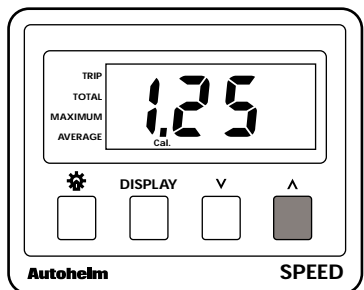

Exit calibration

To exit calibration and return to speed, press and hold **Display** and  for 2 seconds.

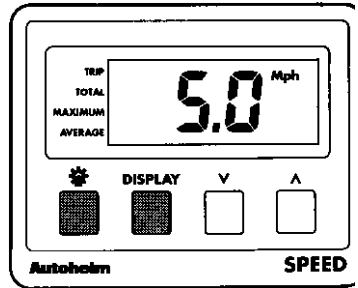

6.2 Calibration Lock/Unlock

The lock/unlock feature removes the risk of accidentally changing the calibration values set for log calibration, shallow alarm etc.

For security, the calibration lock/unlock feature is accessed by an extended hold down of the  and **Display** keys as follows:

1. Press and hold **Display** and  for 14 seconds until **CAL** is displayed for the second time.

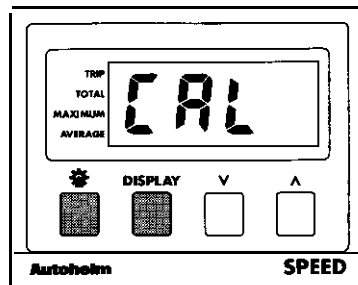

- 2. Momentarily press \wedge and V together.

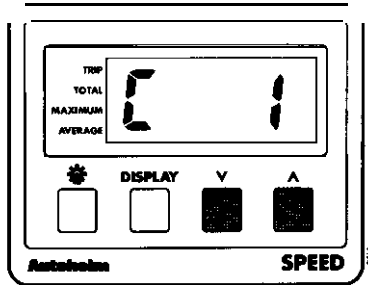

CO = Calibration locked, i.e. no access

CI = Calibration unlocked, i.e. normal access

- 3. Mode selection is altered using \wedge key.

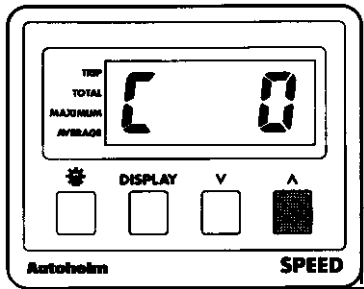

Return to **normal** display

Press and hold Display and \ast . After 2 seconds the display returns to 'Speed' mode.

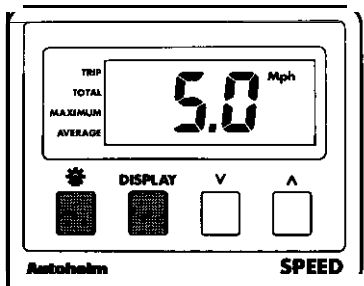

6.3 Master/Repeater display

As it leaves the factory, the ST30 Speed is set to operate in Master mode. In this mode the instrument is connected to a speed transducer and transmits speed information onto the 'SeaTalk' bus. The ST30 Speed can be set up as a Repeater, repeating speed information already on the 'SeaTalk' bus. Repeater mode is set as follows:

1. Press and hold **Display** and  until the display shows U and a two figure number.

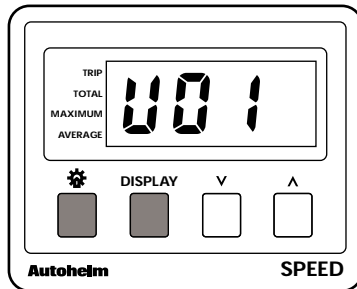

2. Press **Display** to display the operating mode.

r0 = Master mode

r1 = Repeater mode

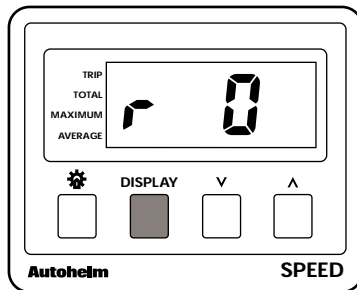

- Press \wedge to change mode.

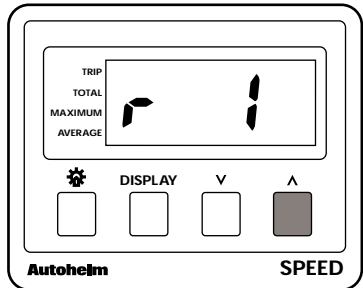

Note: Normal calibration is not available when the ST30 Speed is set to **Repeater** mode.

Return to normal display

To exit calibration and return to speed, press and hold **Display** and \otimes for 2 seconds.

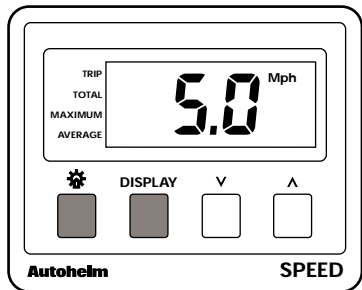

Chapter 7: General Specification

Power supply:	11 to 16V
Power consumption:	40mA (without illumination) 80mA (illuminated)
Temperature range:	0 to 70 deg° C
Dimensions:	110 x 88mm (4.3 x 3.5in)
Illumination:	3 selectable levels
Boat speed:	0 to 99.9 knots or mph (0.1 increments)
Average speed:	0 to 99.9 knots or mph (0.1 increments)
Maximum speed:	0 to 99.9 knots or mph (0.1 increments)
Log:	0 to 5999nm or miles (0.1 increments to 99.9 and 1.0 to 999)
Trip distance:	0 to 999nm or miles (0.01 increments to 9.99, 0.1 to 99.9 and 1.0 to 999)
Units:	Software programmable selection in knots (nm) or mph (miles) – stored in EEPROM and programmable selection of nautical miles independent of knots/mph
Calibration lock/unlock:	Software programmable
Manual log calibration:	0.25 to 1.50 (multiplication factor)
Repeater capability:	Software programmable

Autohelm[®]

A **Raytheon** Company

Nautech Limited, Anchorage Park, Portsmouth
PO3 5TD, England
Telephone (0705) 693611. Fax (0705) 694642

Autohelm[®]

A **Raytheon** Company

Nautech Limited, Anchorage Park, Portsmouth
PO3 5TD, England
Telephone (0705) 693611. Fax (0705) 694642