



INSTRUCTION MANUAL

VHF MARINE TRANSCEIVER **IC-M603**



Icom Inc.

FOREWORD

Thank you for purchasing this Icom transceiver. The IC-M603 VHF MARINE TRANSCEIVER is designed and built with Icom's state of the art technology and craftsmanship. With proper care, this transceiver should provide you with years of trouble-free operation.

We want to take a couple of moments of your time to thank you for making the IC-M603 your radio of choice, and hope you agree with Icom's philosophy of "technology first." Many hours of research and development went into the design of your IC-M603.

◇ **FEATURES**

- *Built-in DSC meets ITU Class D requirement*
- *Rugged waterproof construction*
- *Large LCD with dot matrix characters*
- *Front and rear panel microphone connection*
- *Optional COMMANDMICIII™ (HM-162E) are available and up to two COMMANDMICIII™s can be connected*

Icom, Icom Inc. and the ICOM logo are registered trademarks of Icom Incorporated (Japan) in the United States, the United Kingdom, Germany, France, Spain, Russia and/or other countries.

COMMANDMIC is a registered trademark of Icom Incorporated (Japan) in the United States.

IMPORTANT

READ ALL INSTRUCTIONS carefully and completely before using the transceiver.

SAVE THIS INSTRUCTION MANUAL — This instruction manual contains important operating instructions for the IC-M603.

EXPLICIT DEFINITIONS

WORD	DEFINITION
⚠ WARNING!	Personal injury, fire hazard or electric shock may occur.
CAUTION	Equipment damage may occur.
NOTE	Recommended for optimum use. No risk of personal injury, fire or electric shock.

<p>CLEAN THE TRANSCEIVER AND MICROPHONE THOROUGHLY WITH FRESH WATER after exposure to water including salt, otherwise, the keys and switch may become inoperable due to salt crystallization.</p>
--

IN CASE OF EMERGENCY

If your vessel requires assistance, contact other vessels and the Coast Guard by sending a Distress call on Channel 16.

USING CHANNEL 16

DISTRESS CALL PROCEDURE

1. "MAYDAY MAYDAY MAYDAY."
2. "THIS IS" (name of vessel).
3. Say your call sign or other indication of the vessel (AND 9-digit DSC ID if you have one).
4. "LOCATED AT" (your position).
5. State the nature of the distress and assistance required.
6. Give any other information which might facilitate the rescue.

Or, transmit your Distress call using digital selective calling on Channel 70.

USING DIGITAL SELECTIVE CALLING (Ch 70)

DISTRESS CALL PROCEDURE

1. While lifting up the key cover, push and hold **[DISTRESS]** for 5 sec. until you hear 5 short beeps change to one long beep.
2. Wait for an acknowledgment on Channel 70 from a coast station.
 - After the acknowledgement is received, Channel 16 is automatically selected.
3. Push and hold **[PTT]**, then transmit the appropriate information as listed above.

INSTALLATION NOTE

The installation of this equipment should be made in such a manner as to respect the EC recommended electromagnetic field exposure limits (1999/519/EC).

The maximum RF power available from this device is 25 watts. The antenna should be installed as high as possible for maximum efficiency and that this installation height should be at least 5 meters above ground (or accessible) level. In the case where an antenna cannot be installed at a reasonable height, then the transmitter should neither be continuously operated for long periods if any person is within 5 meters of the antenna, nor operated at all if any person is touching the antenna.

In all cases any possible risk depends on the transmitter being activated for long periods. (actual recommendation limits are specified as an average of 6 minutes) Normally the transmitter is not active for long periods of time. Some radio licenses will require that a timer circuit automatically cuts the transmitter after 1–2 minutes etc.

Similarly some types of transmitter, SSB, CW, AM, etc. have a lower 'average' output power and the perceived risk is even lower.

DOC



CE versions of the IC-M603 which display the “CE” symbol on the serial number seal, comply with the essential requirements of the European Radio and Telecommunication Terminal Directive 1999/5/EC.



This warning symbol indicates that this equipment operates in non-harmonised frequency bands and/or may be subject to licensing conditions in the country of use. Be sure to check that you have the correct version of this radio or the correct programming of this radio, to comply with national licensing requirement.

	DECLARATION OF CONFORMITY
We Icom Inc. Japan 1-1-32, Kamiminami, Hirano-ku Osaka 547-0003, Japan	CE0560
Declare on our sole responsibility that this equipment complies with the essential requirements of the Radio and Telecommunications Terminal Equipment Directive, 1999/5/EC, and that any applicable Essential Test Suite measurements have been performed.	Düsseldorf 1st Jul. 2006 Place and date of issue
Kind of equipment: VHF MARINE TRANSCEIVER	Icom (Europe) GmbH Himmelgeisterstraße 100 D-40225 Düsseldorf
Type-designation: IC-M603	Authorized representative name
Version (where applicable):	H. Ikegami General Manager
This compliance is based on conformity with the following harmonised standards, specifications or documents:	
i) EN 301 025-2 V1.2.1 (2004-09) ii) EN 301 025-3 V1.2.1 (2004-09) iii) EN 60945 2002 iv) EN 60950-1 2001 v) EN 300 698-2 V1.1.1 (2000-08) vi) EN 300 698-3 V1.1.1 (2001-05)	Signature
	Icom Inc.

TABLE OF CONTENTS

FOREWORD	i
IMPORTANT	i
EXPLICIT DEFINITIONS	i
IN CASE OF EMERGENCY	ii
INSTALLATION NOTE	ii
DOC	iii
TABLE OF CONTENTS	iv
PRECAUTIONS	v
1 OPERATING RULES	1
2 PANEL DESCRIPTION	2 – 6
■ Panel description	2
■ Function display	4
■ Microphone	6
3 BASIC OPERATION	7 – 12
■ Channel selection	7
■ Receiving and transmitting	9
■ Call channel programming	10
■ Microphone lock function	10
■ Display backlight	10
■ Channel comments	11
■ AquaQuake water draining function	11
■ Optional Voice scrambler operation	12
4 DUALWATCH/TRI-WATCH	13
■ Description	13
■ Operation	13
5 SCAN OPERATION	14 – 15
■ Scan types	14
■ Setting TAG channels	15
■ Starting a scan	15
6 DSC OPERATION	16 – 38
■ MMSI code programming	16

■ DSC address ID	16
■ Position and Time programming	18
■ Position and Time indication	19
■ GPS information indication	19
■ Distress call	20
■ Transmitting DSC calls	23
■ Receiving DSC calls	32
■ Received messages	36
■ DSC Set mode	37
7 OTHER FUNCTIONS	39 – 42
■ Intercom operation	39
■ Hailer operation	40
■ Automatic foghorn	41
■ RX speaker function	42
8 SET MODE	43 – 45
■ Set mode programming	43
■ Set mode items	43
9 CONNECTIONS AND MAINTENANCE	46 – 53
■ Connections	46
■ Antenna	47
■ Fuse replacement	47
■ Supplied accessories	47
■ Microphone hanger	47
■ Mounting the transceiver	48
■ MB-75 installation	49
■ Optional unit installation	50
■ HM-162E installation	51
10 TROUBLESHOOTING	53
11 SPECIFICATIONS AND OPTIONS	54 – 55
■ Specifications	54
■ Options	55
12 CHANNEL LIST	56 – 57



PRECAUTIONS

⚠ WARNING! NEVER connect the transceiver to an AC outlet. This may pose a fire hazard or result in an electric shock.

NEVER connect the transceiver to a power source of more than 16 V DC or use reverse polarity. This will ruin the transceiver.

NEVER cut the DC power cable between the DC plug and fuse holder. If an incorrect connection is made after cutting, the transceiver may be damaged.

NEVER place the transceiver where normal operation of the vessel may be hindered or where it could cause bodily injury.

KEEP the transceiver at least 1 m away from the ship's navigation compass.

DO NOT use or place the transceiver in areas with temperatures below -20°C or above $+60^{\circ}\text{C}$ or, in areas subject to direct sunlight, such as the dashboard.

AVOID the use of chemical agents such as benzine or alcohol when cleaning, as they may damage the transceiver surfaces. If the transceiver becomes dusty or dirty, wipe it clean with a soft, dry cloth.

BE CAREFUL! The transceiver rear panel will become hot when operating continuously for long periods. Place the transceiver in a secure place to avoid inadvertent use by children.

BE CAREFUL! The transceiver and the optional HM-162E* COMMANDMICIII™ employ waterproof construction, which correspond to IPX7 (transceiver) and IPX8 (HM-162E) respectively, of the international standard IEC 60529 (2001). However, once the transceiver or microphone has been dropped, waterproofing cannot be guaranteed due to the fact that the case may be cracked, or the waterproof seal damaged, etc.

◇ PRIORITIES

- Read all rules and regulations pertaining to priorities and keep an up-to-date copy handy. Safety and Distress calls take priority over all others.
- You must monitor Channel 16 when you are not operating on another channel.
- False or fraudulent distress signals are prohibited and punishable by law.

◇ PRIVACY

- Information overheard but not intended for you cannot lawfully be used in any way.
- Indecent or profane language is prohibited.

◇ RADIO LICENSES

(1) SHIP STATION LICENSE

You must have a current radio station license before using the transceiver. It is unlawful to operate a ship station which is not licensed.

Inquire through your dealer or the appropriate government agency for a Ship-Radiotelephone license application. This government-issued license states the call sign which is your craft's identification for radio purposes.

(2) OPERATOR'S LICENSE

A Restricted Radiotelephone Operator Permit is the license most often held by small vessel radio operators when a radio is not required for safety purposes.

The Restricted Radiotelephone Operator Permit must be posted or kept with the operator. Only a licensed radio operator may operate a transceiver.

However, non-licensed individuals may talk over a transceiver if a licensed operator starts, supervises, ends the call and makes the necessary log entries.

Keep a copy of the current government rules and regulations handy.

■ Panel description

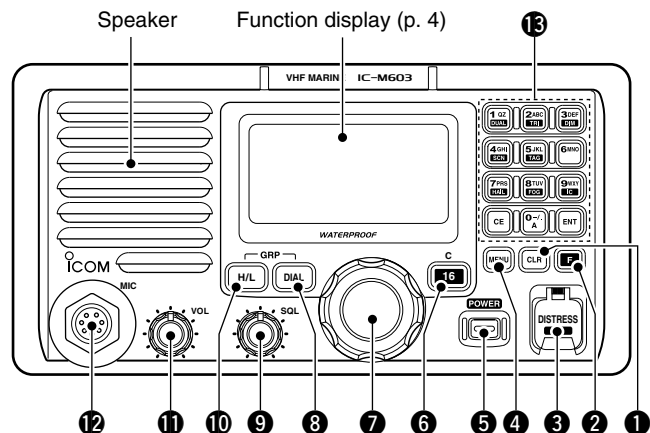

1 CLEAR KEY [CLR]

Push to cancel the entered function, exit Set mode. (p. 43)

2 FUNCTION KEY [F]

After pushing this key, some keys perform secondary function.

- “F” appears when a secondary function can be accessed.

3 DISTRESS KEY [DISTRESS] (pgs. 20, 22)

Push and hold for 5 sec. to transmit a Distress call.

4 DSC MENU KEY [MENU] (p. 16)

Push to toggle the DSC menu ON or OFF.

5 POWER KEY [POWER] (p. 9)

- ➔ Push to turn power ON.
- ➔ Push and hold for 1 sec. to turn power OFF.

6 CHANNEL 16/CALL CHANNEL KEY [16•C]

- ➔ Push to select Channel 16. (p. 7)
- ➔ Push and hold for 1 sec. to select call channel. (p. 7)
 - “CALL” appears when call channel is selected.
- ➔ Push and hold for 3 sec. to enter call channel programming condition when call channel is selected. (p. 10)
- ➔ While pushing and holding [H/L], push to enter channel comments programming condition. (p. 11)
- ➔ While turning power ON, push to enter Set mode. (p. 43)

7 SELECTOR DIAL [SELECTOR] (pgs. 7–9)

Rotate to select the operating channels, set mode contents, etc.

8 DIAL KEY [DIAL]

- ➔ Selects to the regular channel. (p. 8)
- ➔ While pushing and holding [H/L], push to select one of three channel groups in sequence. (p. 8)
 - EUR version has International channels only and this function is not available.

9 SQUELCH CONTROL [SQL] (p. 9)

Rotate to set the squelch threshold level.

10 TRANSMIT POWER KEY [H/L]

- ➔ Push to toggle the output power high or low. (p. 9)
 - Some channels are set to low power only.
- ➔ While pushing and holding this key, some keys perform secondary functions.

11 VOLUME CONTROL [VOL] (p. 9)

Rotate to adjust the audio level.

12 MIC CONNECTOR

Connect the supplied microphone only.

CAUTION: NEVER connect other microphone here, such as the optional COMMANDMICIII™. It may cause damage to the transceiver.

13 KEYPAD

- ➔ Inputs numeral for channel number input, etc.
 - After inputting the desired channel number, push [ENT].
 - Push and hold [0•A] to input 'A' for simplex channels.
- ➔ Inputs numeral, alphabet and some symbols for channel comment input.
- ➔ After pushing [F], push to perform the secondary function.
 - Most of secondary function (except TAG channel setting, RX speaker and Auto foghorn functions) can be cleared or cancelled when [CLR] is pushed.



- ➔ Number input: '1'
- ➔ Comment input: '1,' 'Q,' 'Z,' 'q,' 'z' or space
- ➔ After pushing [F], push to turn the Dualwatch function ON or OFF. (p. 13)



- ➔ Number input: '2'
- ➔ Comment input: '2,' 'A,' 'B,' 'C,' 'a,' 'b' or 'c'
- ➔ After pushing [F], push to turn the Tri-watch function ON or OFF. (p. 13)



- ➔ Number input: '3'
- ➔ Comment input: '3,' 'D,' 'E,' 'F,' 'd,' 'e' or 'f'
- ➔ After pushing [F], push this key then rotate [SELECTOR] to adjust the brightness of the LCD and key backlight. (p. 10)



- ➔ Number input: '4'
- ➔ Comment input: '4,' 'G,' 'H,' 'I,' 'g,' 'h' or 'i'
- ➔ After pushing [F], push to start or stop the scan function. (p. 15)



- ➔ Number input: '5'
- ➔ Comment input: '5,' 'J,' 'K,' 'L,' 'j,' 'k' or 'l'
- ➔ After pushing [F], push to set the displayed channel as a TAG channel. (p. 15)
- ➔ While pushing and holding [H/L], push for 3 sec. to clear or set all TAG channels. (p. 15)



- ➔ Number input: '6'
- ➔ Comment input: '6,' 'M,' 'N,' 'O,' 'm,' 'n' or 'o'

2 PANEL DESCRIPTION

7 PRS
HAIL

- ➔ Number input: '7'
- ➔ Comment input: '7,' 'P,' 'R,' 'S,' 'p,' 'r' or 's'
- ➔ After pushing **[F]**, push to turn the Hailer function ON or OFF. (p. 40)
- ➔ After pushing **[F]**, push and hold for 1 sec. to turn the RX speaker function ON or OFF. (p. 42)

8 TUV
FOG

- ➔ Number input: '8'
- ➔ Comment input: '8,' 'T,' 'U,' 'V,' 't,' 'u' or 'v'
- ➔ After pushing **[F]**, push to turn the Automatic foghorn function ON or OFF. (p. 42)

9 WXY
IC

- ➔ Number input: '9'
- ➔ Comment input: '9,' 'W,' 'X,' 'Y,' 'w,' 'x' or 'y'
- ➔ After pushing **[F]**, push to turn the Intercom function ON or OFF. (p. 39)

0 -/.
A

- ➔ Number input: '0'
- ➔ Number input: Push and hold for 1 sec. to edit 'A' for simplex channel.
- ➔ Comment input: '0' and symbols ('-'/'/')
- ➔ After pushing **[F]**, push to activate an optional Voice scrambler function. (p. 12)
 - The optional Voice Scrambler function cannot be used on Channel 16 and 70.

ENT

- ➔ Push to enter the input channel comment, selected item, etc.

CE

- ➔ Push to clear the entered data.

■ Function display

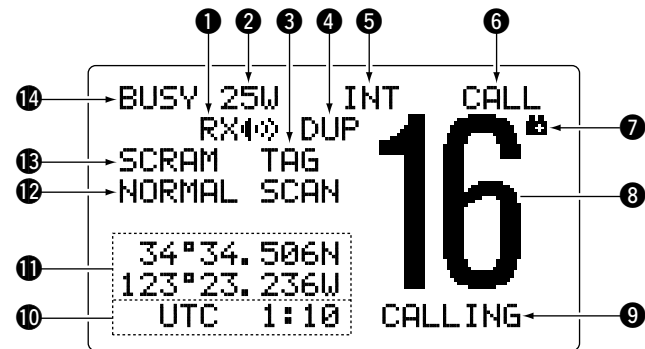

- 1 RX SPEAKER INDICATOR** (p. 42)
Appears during the RX speaker mode.
- 2 POWER INDICATOR** (p. 9)
 - ➔ "25W" appears when high power is selected.
 - ➔ "1W" appears when low power is selected.
- 3 TAG CHANNEL INDICATOR** (p. 15)
Appears when a TAG channel is selected.
- 4 DUPLEX INDICATOR** (p. 8)
Appears when a duplex channel is selected.

5 CHANNEL GROUP INDICATOR (p. 8)

Indicates whether an International “**INT**,” U.S.A. “**USA**,” DSC “**DSC**” or ATIS “**ATIS**” channel is in use. (Depends on version)

6 CALL CHANNEL INDICATOR (pgs. 7, 10)

Appears when the call channel is selected.

7 LOW BATTERY INDICATOR

Blinks when the battery voltage drops to approx. 10 V DC or below.

8 CHANNEL NUMBER READOUT

Indicates the selected operating channel number.

9 CHANNEL COMMENT INDICATOR

Channel comment appears if programmed. (p. 11)

10 TIME ZONE INDICATOR

➔ Shows the current time data when a GPS receiver is connected.

- “??” may blink every 2 sec. instead of current time data when the GPS current time data is invalid.
- “??” may blink every 2 sec. instead of current time data 4 hours after the time data is input manually, up until 23.5 hours have past.

➔ “**Local**” appears when the offset time data is set. (p. 38)

➔ “**No Time**” appears when no GPS receiver is connected and no time data is input manually.

11 POSITION INDICATOR

➔ Shows the GPS position data.

- “??” may blink every 2 sec. instead of position data when the GPS position data is invalid. In such a case, the last position data is held for up to 23.5 hours.
- “??” may blink every 2 sec. instead of position data 4 hours after the position data is input manually, up until 23.5 hours have past.

➔ “**No Position**” appears when no GPS receiver is connected and no position data is input manually.

12 SCAN INDICATOR

➔ “**PRI-SCAN 16**” appears during Priority scan; “**NORMAL SCAN**” appears during Normal scan. (p. 15)

➔ “**DUAL 16**” appears during Dualwatch; “**TRI 16**” appears during Tri-watch. (p. 13)

13 SCRAMBLER INDICATOR (p. 12)

Appears when the voice scrambler function is activated. (only when the optional scrambler unit is installed.)

14 BUSY/TRANSMIT INDICATOR (p. 9)

➔ “**BUSY**” appears when receiving a signal or when the squelch opens.

➔ “**Tx**” appears while transmitting.

2 PANEL DESCRIPTION

■ Microphone

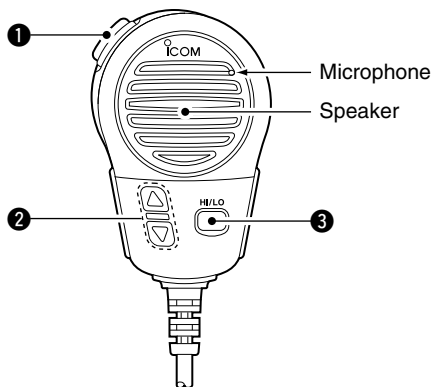

1 PTT SWITCH [PTT]

Push and hold to transmit; release to receive. (p. 9)

2 CHANNEL UP/DOWN KEYS [▲]/[▼]

- ➔ Push either key to change the operating channels, Set mode settings, etc. (pgs. 7–9, 43)
- ➔ Checks TAG channels, changes scanning direction or resumes the scan manually during scan. (p. 15)

3 TRANSMIT POWER KEY [HI/LO]

- ➔ Push to toggle the power high and low. (p. 9)
 - Some channels are set to low power only.
- ➔ While pushing and holding [HI/LO], turn power ON to toggle the Microphone lock function ON and OFF. (p. 10)

■ Channel selection

◇ Channel 16

Channel 16 is the distress and safety channel. It is used for establishing initial contact with a station and for emergency communications. Channel 16 is monitored during both Dual-watch and Tri-watch. While standing by, you must monitor Channel 16.

- Push **[16•C]** momentarily to select Channel 16.
- Push **[DIAL]** to return to the condition before selecting Channel 16, or rotate **[SELECTOR]** to select a channel.
 - Pushing the keypad or **[▲]/[▼]** on the microphone also selects a channel.

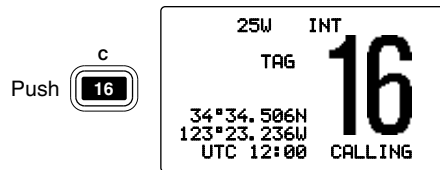

Convenient!

When the Favorite channel function is turned ON (p. 45), **[▲]/[▼]** keys on the microphone select the favorite channels in the selected channel group in sequence when pushed.

- The favorite channels are set by the TAG channel setting. (p. 15)

◇ Call channel

Each regular channel group has a separate leisure-use call channel. The call channel is monitored during Tri-watch. The call channels can be programmed (p. 10) and are used to store your most often used channel in each channel group for quick recall.

- Push and hold **[16•C]** for 1 sec. to select the call channel of the selected channel group.
 - “CALL” and call channel number appear.
 - Each channel group may have an independent call channel after programming a call channel. (p. 10)
- Push **[DIAL]** to return to the condition before selecting call channel, or rotate **[SELECTOR]** to select a channel.
 - Pushing the keypad or **[▲]/[▼]** on the microphone also selects a channel.

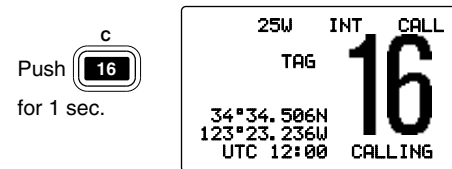

3 BASIC OPERATION

◆ International channels

There are pre-programmed 57 international channels for the IC-M603.

- ① Push **[DIAL]** to select a regular channel.
- ② While pushing and holding **[H/L]**, push **[DIAL]** to change the channel group, if necessary.
 - “**INT**” appears when International channel is selected.
- ③ Rotate **[SELECTOR]** to select a channel.
 - “**DUP**” appears for duplex channels.
 - Pushing the keypad or **[▲]/[▼]** on the microphone also selects a channel.

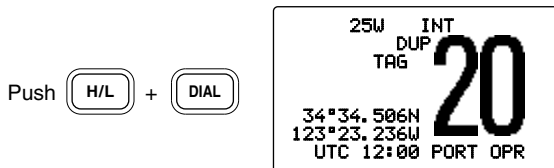

◆ U.S.A. channels (U.K. version only)

For U.K. version, there are pre-programmed 61 U.S.A. channels in addition to 59 International channels.

- ① Push **[DIAL]** to select a regular channel.
- ② While pushing and holding **[H/L]**, push **[DIAL]** to change the channel group, if necessary.
 - International and U.S.A. channels can be selected in sequence.
- ③ Rotate **[SELECTOR]** to select a channel.
 - “**DUP**” appears for duplex channels.
 - Pushing the keypad or **[▲]/[▼]** on the microphone also selects a channel.

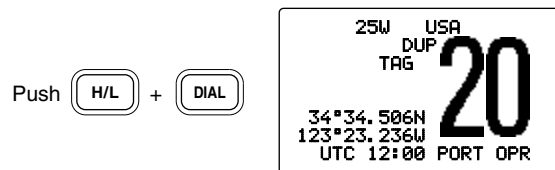

◆ ATIS and DSC channels (Holland and FRG versions only)

For Holland and FRG version, there are pre-programmed 57 ATIS and 57 DSC* channels in addition to 58 (Holland version) or 56 (FRG version) International channels.

*FRG version only

- ① Push **[DIAL]** to select a regular channel.
- ② While pushing and holding **[H/L]**, push **[DIAL]** to change the channel group, if necessary.
 - International, ATIS and DSC channels can be selected in sequence.
- ③ Rotate **[SELECTOR]** to select a channel.
 - “**DUP**” appears for duplex channels.
 - Pushing the keypad or **[▲]/[▼]** on the microphone also selects a channel.

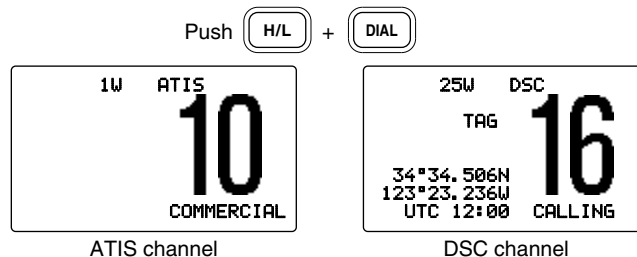

■ Receiving and transmitting

CAUTION: Transmitting without an antenna will damage the transceiver.

- ① Push **[POWER]** to turn power ON.
- ② Set the audio and squelch levels.
 - ➔ Rotate **[SQL]** fully counterclockwise in advance.
 - ➔ Rotate **[VOL]** to adjust the audio output level.
 - ➔ Rotate **[SQL]** clockwise until the noise disappears.
- ③ While pushing and holding **[H/L]**, push **[DIAL]** several times to change the channel group. (p. 8)
- ④ Rotate **[SELECTOR]** to select a channel. (pgs. 6, 7, 57)
 - Pushing the keypad or **[▲]/[▼]** on the microphone also selects a channel.
 - When receiving a signal, “**BUSY**” appears and audio is emitted from the speaker.
 - Further adjustment of **[VOL]** may be necessary.
- ⑤ Push **[H/L]** to select the output power if necessary.
 - “**25W**” or “**1W**” appears when high or low power is selected, respectively.
 - Choose low power for short range communications, choose high power for longer distance communications.
 - Some channels are for low power only.
- ⑥ Push and hold **[PTT]** to transmit, then speak into the microphone.
 - “**Tx**” appears.
 - Channel 70 cannot be used for transmission other than DSC.
- ⑦ Release **[PTT]** to receive.

IMPORTANT: To maximize the readability of your transmitted signal, pause a few sec. after pushing **[PTT]**, hold the microphone 5 to 10 cm from your mouth and speak at a normal voice level.

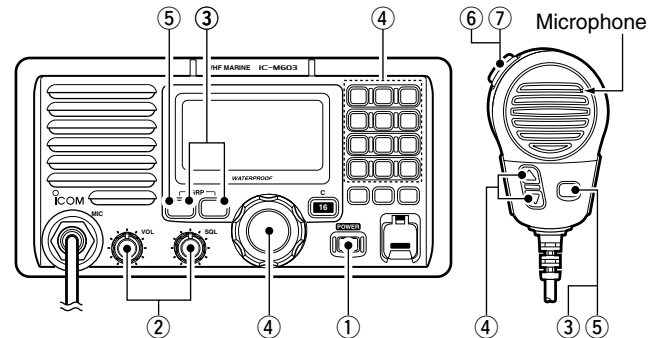

✓ NOTE for TOT (Time-out Timer) function

The TOT function inhibits continuous transmission over a pre-set time period after the transmission starts. A beep sounds 10 sec. before the TOT function activates, to indicate the transmission will be shut down and “**TOT**” appears on the channel comment indicator. Transmission is not possible for 10 sec. after this transmission shut down.

3 BASIC OPERATION

■ Call channel programming

You can program the call channel with your most often-used channels in each channel group for quick recall.

- ① While pushing and holding [H/L], push [DIAL] several times to select the desired channel group (INT, USA, ATIS or DSC) to be programmed.
- ② Push and hold [16•C] for 1 sec. to select the call channel of the selected channel group.
 - “CALL” and call channel number appear.
- ③ Push and hold [16•C] again for 3 sec. (until a long beep changes to 2 short beeps) to enter call channel programming condition.
 - Channel number starts blinking.
- ④ Rotate [SELECTOR] to select the desired channel.
- ⑤ Push [16•C] to program the displayed channel as the call channel.
 - Push [CLR] to cancel.
 - The channel number stops blinking.

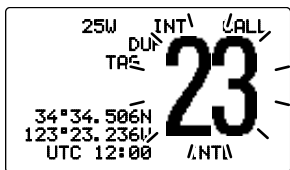
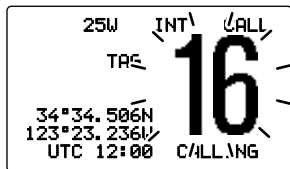

■ Microphone lock function

The Microphone lock function electrically locks [▲]/[▼] and [HI/LO] keys on the supplied microphone. This prevents accidental channel changes and function access.

- ➔ While pushing and holding [HI/LO] on the microphone, turn power ON to toggle the Microphone lock function ON and OFF.

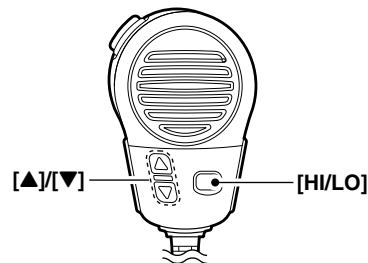

■ Display backlight

The function display and keys can be backlit for better visibility under low light conditions.

- ➔ After pushing [E], push [3•DIM] then rotate [SELECTOR] to adjust the brightness of the LCD and key backlight. Then push [ENT].
- The backlight is adjustable in 7 levels and OFF.

■ Channel comments

Memory channels can be labeled with a unique alphanumeric ID of up to 10 characters each.

Capital letters, small letters, 0 to 9, some symbols (- . /) and space can be used.

- ① Select the desired channel.
 - Cancel Dualwatch, Tri-watch or Scan in advance.
- ② While pushing and holding [H/L], push [10•C] to edit the channel comment.
 - A cursor and the first character start blinking alternately.

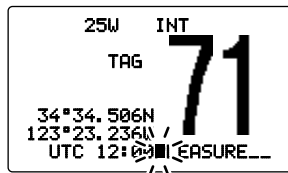

- ③ Push the appropriate key several times to enter the desired character.
 - See the table at right for available characters.
 - Rotate [SELECTOR] or push [▲]/[▼] on the microphone to move the cursor.
 - Push [CE] to clear the channel comment.
 - Push [CLR] to cancel and exit the condition.
- ④ Push [ENT] to input and set the comment.
 - The cursor and the character stop blinking.
- ⑤ Repeat steps ① to ④ to program other channel comments, if desired.

• Available characters

KEY	CHARACTERS	KEY	CHARACTERS
1 QZ DUAL	1 Q Z q z (space)	6 MNO	6 M N O m n o
2 ABC TRI	2 A B C a b c	7 PRS HAIL	7 P R S p r s
3 DEF DIM	3 D E F d e f	8 TUV FOG	8 T U V t u v
4 GHI SCN	4 G H I g h i	9 WXY IC	9 W X Y w x y
5 JKL TAG	5 J K L j k l	0 - / A	0 - / .

■ AquaQuake water draining function

The IC-M603 uses a new technology to clear water away from the speaker grill: AquaQuake. AquaQuake helps drain water away from the speaker housing (water that might otherwise muffle the sound coming from the speaker). The IC-M603 emits a vibrating noise when this function is being used.

- While pushing and holding [H/L], turn power ON.
 - A low beep tone sounds while [H/L] key is pushed and held to drain water, regardless of [VOL] control setting.
 - The transceiver never accepts a key operation while the AquaQuake function is activated.

⚡ While pushing and holding [PTT] on the optional HM-162E, turn power ON to clear water away from the HM-162E.

3 BASIC OPERATION

Optional Voice scrambler operation

◆ Activating the scrambler function

The optional Voice scrambler provides private communications. In order to receive or send scrambled transmissions you must first activate the scrambler function. To activate the function, an optional scrambler unit is necessary. See pgs. 45 and 50 for setting the scrambler unit. Ask your dealer for details.

/// The scrambler function automatically turns OFF when Channel 16 or 70 is selected.

- ① Rotate **[SELECTOR]** to select the desired channel other than Channel 16 and 70.
- ② Push **[F]**, then push **[0]** to turn the Voice scrambler function ON.
 - "SCRAM" appears.
- ③ To turn the scrambler function OFF, repeat step ②.
 - "SCRAM" disappears.

◆ Programming scrambler codes

There are 32 codes (1 to 32) or 128 codes (0 to 127)* available for programming when an optional scrambler unit is installed. In order to understand one another, all transceivers in your group must have the same scramble code. This function may not be available depending on dealer setting.

*Depends on the installed scrambler unit.

- ① While pushing and holding **[16-C]**, push **[POWER]** to enter Set mode.
 - Turn power OFF in advance.
- ② After the display appears, release **[16-C]**.
- ③ Rotate **[SELECTOR]** to select the "Scrambler Code," push **[ENT]**.
- ④ Rotate **[SELECTOR]** to select the desired scrambler code.
- ⑤ Push **[ENT]** to set and exit the scrambler code item.
- ⑥ Push **[CLR]**, or rotate **[SELECTOR]** to select "Exit," then push **[ENT]** to exit Set mode.

[Example]: Programming scrambler code 8.

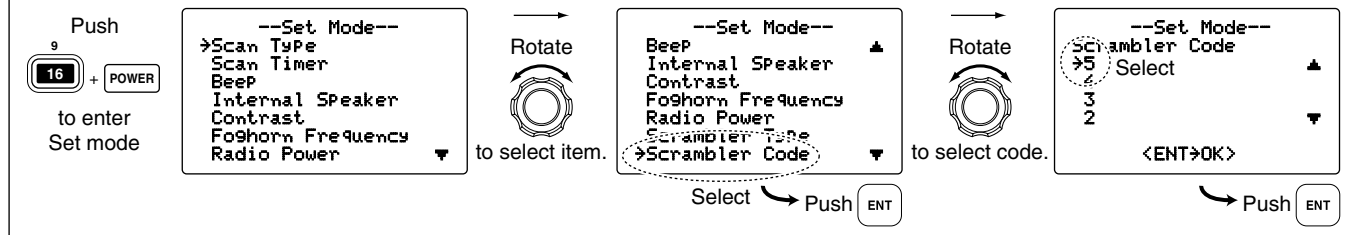

■ Description

Dualwatch monitors Channel 16 while you are receiving on another channel; Tri-watch monitors Channel 16 and the call channel while receiving another channel. Dualwatch/Tri-watch is convenient for monitoring Channel 16 when you are operating on another channel.

DUALWATCH/TRI-WATCH SIMULATION

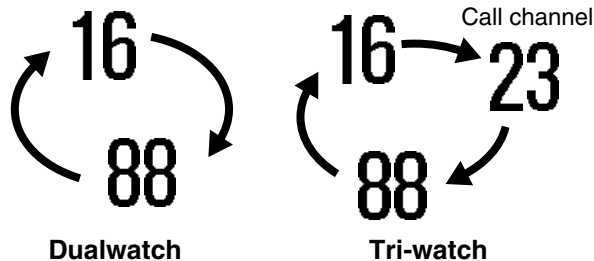

- If a signal is received on Channel 16, Dualwatch/Tri-watch pauses on Channel 16 until the signal disappears.
- If a signal is received on the call channel during Tri-watch, Tri-watch becomes Dualwatch until the signal disappears.
- To transmit on the selected channel during Dualwatch/Tri-watch, push and hold **[PTT]**.

■ Operation

- ① Select the desired channel.
- ② Push **[F]**, then push **[1•DUAL]** to start Dualwatch or **[2•TRI]** to start Tri-watch.
 - “DUAL 16” appears during Dualwatch; “TRI 16” appears during Tri-watch.
 - A beep tone sounds when a signal is received on Channel 16.
- ③ To cancel Dualwatch or Tri-watch, push **[CLR]** or repeat step ②.

[Example]: Operating Tri-watch on INT Channel 25

Tri-watch starts.

```

25W  INT
    DUP
    TAG
    TRI 16
25
34°34.506N
123°23.236W
UTC 12:00 TELEPHONE
    
```

Signal is received on call channel.

```

BUSY 25W  INT  CALL
    DUP
    TAG
    TRI 16
23
34°34.506N
123°23.236W
UTC 12:00 INTL
    
```

Tri-watch resumes after the signal disappears.

```

25W  INT
    DUP
    TAG
    TRI 16
25
34°34.506N
123°23.236W
UTC 12:00 TELEPHONE
    
```

Signal received on Channel 16 takes priority.

```

BUSY 25W  INT
    DUP
    TAG
    TRI >16<
25
34°34.506N
123°23.236W
UTC 12:00 TELEPHONE
    
```

■ Scan types

Scanning is an efficient way to locate signals quickly over a wide frequency range. The transceiver has Priority scan and Normal scan.

Set the TAG channels (scanned channel) before scanning. Clear the TAG channels which inconveniently stop scanning, such as those for digital communication use. (Refer to the right page for details.)

/// Choose Priority or Normal scan in Set mode. (p. 43)

PRIORITY SCAN

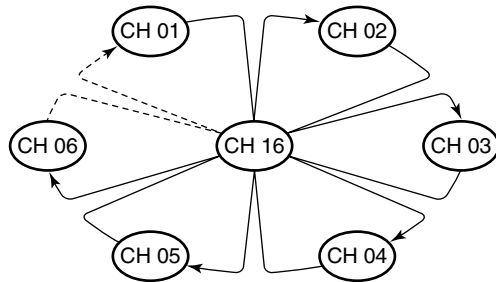

Priority scan searches through all TAG channels in sequence while monitoring Channel 16. When a signal is detected on Channel 16, scan pauses until the signal disappears; when a signal is detected on a channel other than Channel 16, scan becomes Dualwatch until the signal disappears.

NORMAL SCAN

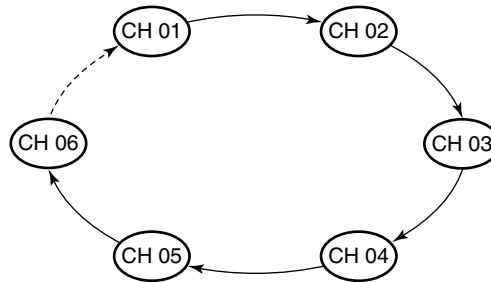

Normal scan, like priority scan, searches through all TAG channels in sequence. However, unlike priority scan, Channel 16 is not checked unless Channel 16 is set as a TAG channel.

■ Setting TAG channels

For more efficient scanning, add the desired channels as TAG channels or clear the TAG for unwanted channels. Channels that are not tagged will be skipped during scanning. TAG channels can be assigned to each channel group (INT, USA, ATIS or DSC) independently.

- ① While pushing and holding [H/L], push [DIAL] several times to select the desired channel group.
- ② Select the desired channel to be set as a TAG channel.
- ③ Push [F], then push [5•TAG] to set the displayed channel as a TAG channel.
 - “TAG” appears in the display.
- ④ To cancel the TAG channel setting, repeat step ③.
 - “TAG” disappears.

Clearing (or setting) all tagged channels

While pushing and holding [H/L], push [5•TAG] for 3 sec. (until a long beep changes to 2 short beeps) to clear all TAG channels setting in the selected channel group.

- Repeat above procedure to set all channels as TAG channels.

[Example]: Starting a normal scan.

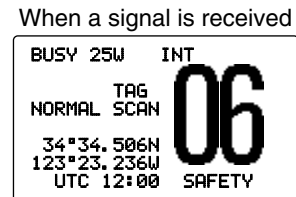
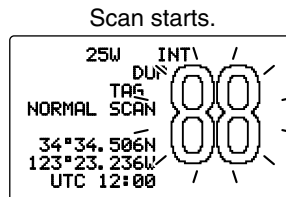
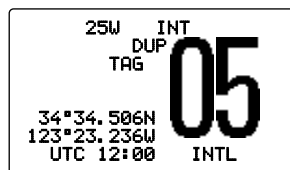

■ Starting a scan

Set scan type (Priority or Normal scan) and scan resume timer in advance using Set mode. (p. 43)

- ① While pushing and holding [H/L], push [DIAL] several times to select the channel group, if desired.
- ② Set TAG channels as described at left.
- ③ Make sure the squelch is closed to start a scan.
- ④ Push [F], then push [4•SCN] to start Priority or Normal scan.
 - “PRI-SCAN 16” or “NORMAL SCAN” appears in the display.
 - When a signal is detected, scan pauses until the signal disappears or resumes after pausing 5 sec. according to Set mode setting. (Channel 16 is still monitored during Priority scan.)
 - Rotate [SELECTOR] or push [▲]/[▼] on the microphone to check the scanning TAG channels, to change the scanning direction or resume the scan manually.
 - A beep tones sounds and “16” blinks when a signal is received on Channel 16 during Priority scan.
- ⑤ To stop the scan, push [CLR] or repeat step ④.

◆ Deleting Individual ID

- Enter “DEL: INDV ID” in DSC Set up menu.

```

<DSC Menu> ⇨ <Set up> ⇨ <DEL: INDV ID>
(Push [MENU]) (Rotate [SELECTOR], then push [ENT].)
    
```

- When no address ID is programmed, “No ID” is displayed. Push [CLR] to exit.

- Rotate [SELECTOR] to select the desired ID name for deleting.

```

--DSC Menu--
Select ID
John
Paul
→George
Michael
                                ▼
<CLR>Exit / <ENT>OK>
    
```

- Push [ENT] to delete the selected individual ID and return to the DSC Set up menu.
- Push [CLR] or rotate [SELECTOR] to select “Exit,” push [ENT] to return to DSC menu.
 - Repeat again to return to the normal operation condition.

◆ Programming Group ID

- Enter “Add: Group ID” in DSC Set up menu.

```

<DSC Menu> ⇨ <Set up> ⇨ <Add: Group ID>
(Push [MENU]) (Rotate [SELECTOR], then push [ENT].)
    
```

- Set the group ID and ID name directly with the keypad.
 - Edit the 8-digits of the group ID directly with the keypad.
 - Rotate [SELECTOR] to move the cursor backward or forward.
 - Push [CE] to clear the ID and name.
 - Push [CLR] to cancel and exit the condition.

```

--DSC Menu--
Add: Group ID
Input 8 digits
|█|-----
Input name
-----
<CLR>Exit / <ENT>OK>
    
```

- Push [ENT] to program and return to the DSC Set up menu.
- Push [CLR] or rotate [SELECTOR] to select “Exit,” push [ENT] to return to DSC menu.
 - Repeat again to return to the normal operation condition.

◆ Deleting Group ID

- Enter “DEL: Group ID” in DSC Set up menu.

```

<DSC Menu> ⇨ <Set up> ⇨ <DEL: Group ID>
(Push [MENU]) (Rotate [SELECTOR], then push [ENT].)
    
```

- When no address ID is programmed, “No ID” is displayed. Push [CLR] to exit.
- Rotate [SELECTOR] to select the desired ID name for deleting.
 - Push [ENT] to delete the selected group ID and return to the DSC Set up menu.
 - Push [CLR] or rotate [SELECTOR] to select “Exit,” push [ENT] to return to DSC menu.
 - Repeat again to return to the normal operation condition.

■ Position and Time indication

When a GPS receiver (NMEA0183 ver. 2.0 or 3.01) is connected, the transceiver displays the current position and time. When no GPS receiver is connected, the transceiver displays the manually entered position and time.

A GPS receiver appropriate for the IC-M603 is not supplied from Icom. A GPS receiver with NMEA0183 ver. 2.0 or 3.01 format is required for position and time indication. Ask your dealer about suitable GPS receivers.

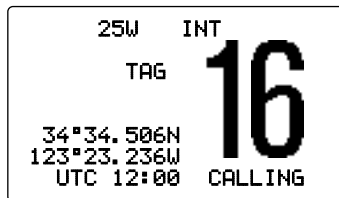

- When the connecting GPS receiver is compatible with several sentence formatters, the order of input precedence is 'RMC,' 'GGA,' 'GNS' and 'GLL.'
- When sentence formatter 'RMC' is received, time indication includes a date. Thus, the "UTC" or "Local" indication is not displayed.
- "???" may blink instead of position and time indications when the GPS data is invalid, or has not been manually updated after 4 hours.

■ GPS information indication

When a GPS receiver (NMEA0183 ver. 2.0 or 3.01) is connected, the transceiver displays the GPS information after pushing and holding [ENT] for 1 sec.

Push  for 1 sec.

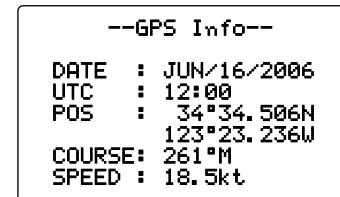

- /// When connecting GPS receiver is compatible with several sentence formatters, the order of input precedence is 'RMC,' 'GGA,' 'GNS,' 'GLL' and 'VTG.'

■ Distress call

A Distress call should be transmitted if, in the opinion of the Master, the ship or a person is in distress and requires immediate assistance.

NEVER USE THE DISTRESS CALL WHEN YOUR SHIP OR A PERSON IS NOT IN AN EMERGENCY. A DISTRESS CALL CAN BE USED ONLY WHEN IMMEDIATE HELP IS NEEDED.

◆ Simple call

- ① Confirm no Distress call is being received.
- ② While lifting up the key cover, push **[DISTRESS]** for 5 sec. to transmit the Distress call.
 - Emergency channel (Channel 70) is automatically selected and the Distress call is transmitted.
 - When no GPS is connected, input your position and UTC time, if possible.
 - While pushing **[DISTRESS]**, the key backlighting blinks.

Distress Call
Push for 5 sec.

- ③ After transmitting the call, the transceiver waits for an acknowledgment call on Channel 70.
 - The Distress call is automatically transmitted every 3.5 to 4.5 minutes.
 - After 2 sec., the transceiver is set to Channel 16 automatically.

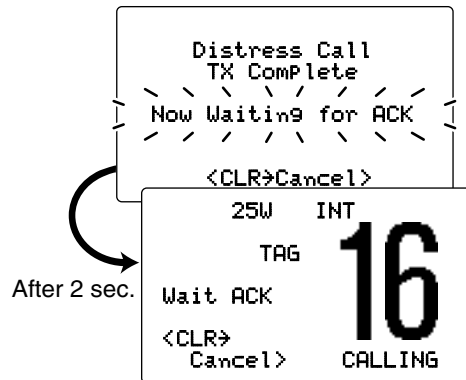

- ④ After receiving the acknowledgment, reply using the microphone.

```

25W INT
TAG
Received
DistressACK
<Osaka Bay
<CLR>
Beep Off> CALLING
16

```

- ➔ A distress alert contains (default);
 - Kind of distress : Undesignated distress
 - Position data : GPS or manual input position data held for 23.5 hrs.
- ➔ The Distress call is repeated every 3.5–4.5 min., until receiving an ‘acknowledgement.’
- ➔ Push **[DISTRESS]** to transmit a renewed Distress call, if required.
- ➔ Push **[CLR]** to cancel the ‘Call repeat’ mode.
- ➔ “??” may blink instead of position and time indications when the GPS data is invalid, or has not been manually updated after 4 hours.

◇ Regular call

The nature of the Distress call should be included in the Distress call.

- ① Enter “Distress Setting” in DSC menu.

```

<DSC Menu> ⇄ <Distress Setting>
(Push [MENU]) (Rotate [SELECTOR], then push [ENT].)

```

- ② Rotate **[SELECTOR]** to select the nature of the distress, push **[ENT]**.

- ‘Undesignated,’ ‘Explosion,’ ‘Flooding,’ ‘Collision,’ ‘Grounding,’ ‘Capsizing,’ ‘Sinking,’ ‘Adrift (Disable adrift),’ ‘Abandoning (Abandoning ship),’ ‘Piracy (Piracy attack)’ and ‘MOB (Man overboard)’ are available.
- The selected nature of the distress is stored for 10 minutes after selecting is finished.

```

--DSC Menu--
Select Nature
Undesignated
→Explosion
Flooding
Collision
<CLR>Exit / ENT→OK>

```

- ➔ When a GPS receiver (NMEA0183 ver. 2.0 or 3.01) is connected, steps ③ and ④ (Current position/time programming) do not appear. Go to step ⑤.

6 DSC OPERATION

- ③ The position information appears. Edit your position (latitude and longitude) data directly with the keypad.
- Push **[6•MNO]** to edit N; North latitude or **[7•PRS]** to edit S; South latitude.
 - Push **[3•DEF]** to edit E; East longitude or **[9•WXY]** to edit W; West longitude.
 - Rotate **[SELECTOR]** to move the cursor backward or forward.
 - Push **[CE]** to clear the position data.
 - Push **[CLR]** to cancel and exit the condition.

```
--DSC Menu--
Input Position
Latitude
┌─┴─┐───N      Null
└─┬─┘
Longitude
┌─┴─┐───W      Null
└─┬─┘
--<CE>Null Data>
<CLR>Exit / ENT>OK>
```

- ④ After editing the position data, push **[ENT]** to set. Then edit the current UTC time with the keypad, push **[ENT]**.
- Edit the digit of the current UTC time directly with the keypad.
 - Rotate **[SELECTOR]** to move the cursor backward or forward.
 - Push **[CE]** to clear the time.
 - Push **[CLR]** to cancel and exit the condition.

```
--DSC Menu--
Input UTC Time
┌─┴─┐───
└─┬─┘
--<CE>Null Data>
<CLR>Exit / ENT>OK>
```

- ⑤ Push **[DISTRESS]** for 5 sec. to transmit the Distress call.
- While pushing **[DISTRESS]**, the key backlighting blinks.
 - The selected nature of the distress is stored for 10 minutes.
- ⑥ After transmitting the Distress call, the transceiver waits for an acknowledgment call on Channel 70.
- The Distress call is automatically transmitted every 3.5 to 4.5 min.
 - After 2 sec., the transceiver is set to Channel 16 automatically.

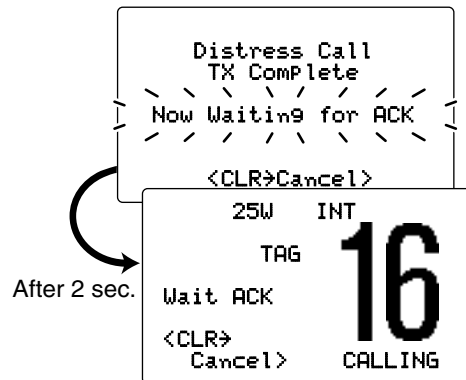

- ⑦ After receiving the acknowledgment, reply using the microphone.

```

      25W   INT
      TAG
Received
DistressACK
<Osaka Bay
<CLR>
  Beep Off>   CALLING
  16
  
```

- ➔ A distress alert contains (default);
 - Kind of distress : Selected nature of the distress
 - Position data : GPS or manual input position data is held for 23.5 hrs. or until the power is turned OFF.
- ➔ The Distress call is repeated every 3.5–4.5 min., until receiving an ‘acknowledgement.’
- ➔ Push **[DISTRESS]** to transmit a renewed Distress call, if required.
- ➔ Push **[CLR]** to cancel the ‘Call repeat’ mode.
- ➔ “??” may blink instead of position and time indications when the GPS data is invalid, or has not been manually updated after 4 hours.

■ Transmitting DSC calls

- ▨ To ensure correct operation of the DSC function, please make sure you set the squelch correctly. (p. 9)

◆ Transmitting an Individual call

The Individual call function allows you to transmit a DSC signal to a specific ship only.

- ① Enter “**Individual Call**” in DSC menu.

```

<DSC Menu> ⇄ <Individual Call>
(Push [MENU]) (Rotate [SELECTOR], then push [ENT].)
  
```

- ② Rotate **[SELECTOR]** to select the desired pre-programmed individual address or “**Manual InPut**,” push **[ENT]**.
- The ID code for the Individual call can be set in advance. (p. 16)
 - When “**Manual InPut**” is selected, set the 9-digit MMSI ID code for the individual you wish to call with the keypad.

```

--DSC Menu--
Select Address
Manual InPut
John
➔Paul
George
  
```

<CLR>Exit / <ENT>OK>

6 DSC OPERATION

- ③ Rotate [SELECTOR] to select a desired intership channel or "Manual Input," push [ENT].
- Intership channels are already preset into the transceiver in recommended order.

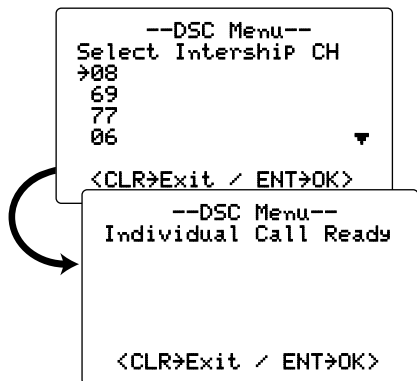

- ④ Push [ENT] to transmit the Individual call.
- If Channel 70 is busy, the transceiver stands by until the channel becomes clear.
- ⑤ Standby on Channel 70 until an acknowledgement is received.

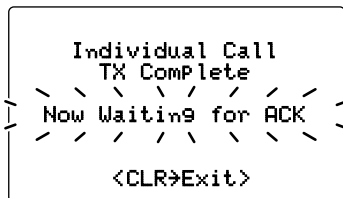

- ⑥ When the acknowledgement 'Able to comply' is received, the specified channel (in step ③) is selected with beeps automatically. Or, when the acknowledgement 'Unable to comply' is received, the display returns to the operated channel (before enter the DSC menu) with beeps.

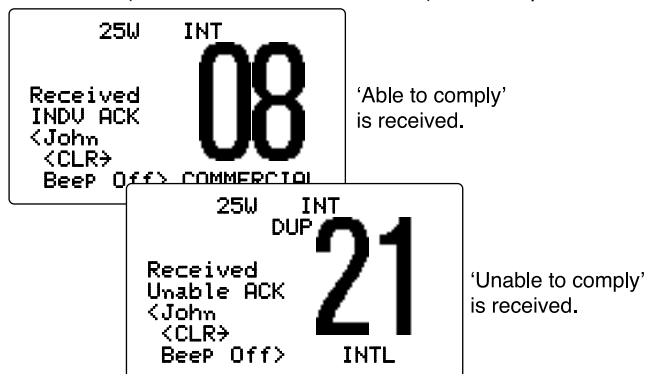

- ⑦ Push [CLR] to stop the beep, then push and hold [PTT] to communicate your message to the responding ship.

◆ Transmitting an Individual Acknowledgement

When receiving an Individual call, you can transmit an acknowledgement ('Able to comply' or 'Unable to comply') by using the on screen prompts (see page 33 for details). You can also send an acknowledgement through the menu system as follows.

- ① Enter "Individual ACK" in DSC menu.

```
<DSC Menu> ⇄ <Individual ACK>
(Push [MENU]) (Rotate [SELECTOR], then push [ENT].)
```

• "Individual ACK" item appears after an Individual call is received.

- ② Rotate [SELECTOR] to select the desired individual address or ID code, push [ENT].

```
--DSC Menu--
Select Address
John
>Paul
George

<CLR>Exit / <ENT>OK>
```

- ③ Rotate [SELECTOR] to select "Able to Comply" or "Unable to Comply," push [ENT].
- When "Unable to Comply," is selected, 'No reason given' will be transmitted.

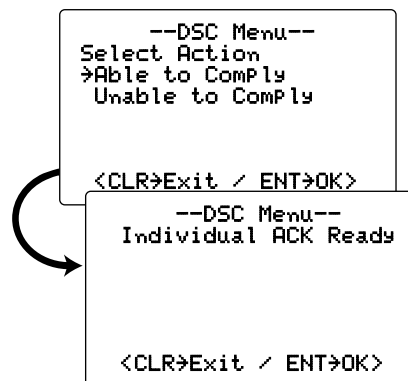

- ④ Push [ENT] to transmit the acknowledgement call to the selected station.
- ⑤ After the Individual acknowledgement call has been transmitted, the specified channel (specified by the calling station) is selected automatically when "Able to Comply" is selected, or returns to the previous condition (before entering the DSC menu) when "Unable to Comply" is selected in step ③.

6 DSC OPERATION

◆ Transmitting a Group call

The Group call function allows you to transmit a DSC signal to a specific group only.

- ① Enter "Group Call" in DSC menu.

```
<DSC Menu> ⇄ <Group Call>
(Push [MENU])      (Rotate [SELECTOR], then push [ENT].)
```

- ② Rotate [SELECTOR] to select the desired pre-programmed group address or "Manual InPut," push [ENT].

- The ID code for the Group call can be set in advance. (p. 17)
- When "Manual InPut" is selected, set the 8-digit ID code for the group you wish to call with keypad.

```
--DSC Menu--
Select Address
Manual InPut
>Icom
Coast station

<CLR>Exit / <ENT>OK>
```

- ③ Rotate [SELECTOR] to select a desired intership channel or "Manual InPut," push [ENT].

- Intership channels are already preset into the transceiver in recommending order.

```
--DSC Menu--
Select Intership CH
>08
69
77
06
<CLR>Exit / <ENT>OK>

--DSC Menu--
Group Call Ready

<CLR>Exit / <ENT>OK>
```

- ④ Push [ENT] to transmit the Group call.
 - If Channel 70 is busy, the transceiver stands by until the channel becomes clear.
- ⑤ After the Group call has been transmitted, the following indication is displayed.

```
Group Call
TX Complete

<CLR>Exit>
```

- ⑥ Push [CLR] to exit and the transceiver selects the intership channel specified in step ③ automatically.
 - Even if [CLR] hasn't been pushed, the transceiver selects the specified intership channel in step ③ automatically after 2 sec. of inactivity.

◆ Transmitting an All Ships call

Large ships use Channel 70 as their 'listening channel.' When you want to announce a message to all ships within range, use the 'All Ships Call' function.

- ① Enter "All Ships Call" in DSC menu.

```
<DSC Menu> ⇄ <All Ships Call>
(Push [MENU]) (Rotate [SELECTOR], then push [ENT].)
```

- ② Rotate [SELECTOR] to select the desired category, push [ENT].

- Output power of 'Routine' category is 1 W (low power) only.
- The selectable category may differ according to the programmed setting. Ask your dealer for the available categories.

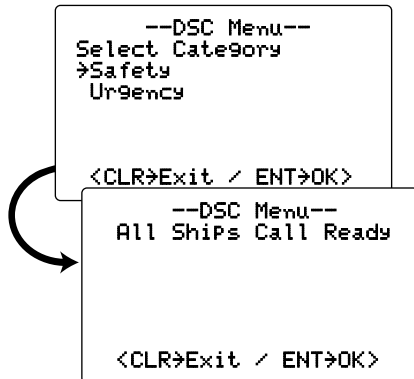

- ③ Push [ENT] to transmit the All ships call.
 - Channel 70 is selected and the All ships call is transmitted.
- ④ After the All ships call has been transmitted, the following indication is displayed.

```
All Ships Call
TX Complete

<CLR>Exit>
```

- ⑤ Push [CLR] to exit and the transceiver selects Channel 16 automatically.
 - Even if [CLR] hasn't been pushed, the transceiver automatically selects Channel 16 after 2 sec. inactivity.

6 DSC OPERATION

◆ Transmitting a Position Request call

Transmit a Position Request call when you want to know a specific ship's current position, etc.

- ① Enter "Position Request" in DSC menu.

```
<DSC Menu> ⇨ <Position Request>
(Push [MENU]) (Rotate [SELECTOR], then push [ENT].)
```

- ② Rotate [SELECTOR] to select the desired pre-programmed individual address or "Manual Input," push [ENT].

- The ID code can be set in advance. (p. 16)
- When "Manual Input" is selected, set the 9-digit MMSI number for the individual you wish to call with the keypad.

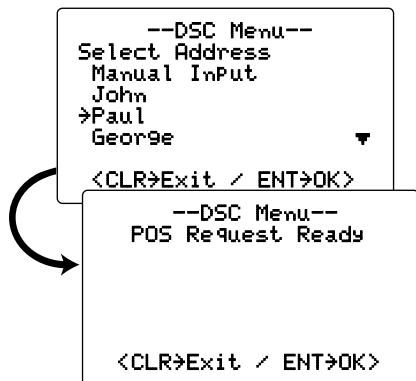

- ③ Push [ENT] to transmit the Position Request call.
 - If Channel 70 is busy, the transceiver stands by until the channel becomes clear.

- ④ After the Position Request call has been transmitted, the following indication is displayed.

```
Position Request
TX Complete
-----
Now Waiting for ACK
-----
<CLR>Exit
```

- ⑤ Push [CLR] to return to the previous indication before entering the DSC menu.
 - Even if [CLR] hasn't been pushed, the display automatically returns to the previous indication after 2 sec. of inactivity.

◆ Transmitting a Position Report call

Transmit a Position Report call when you want to announce your own position to a specific ship and to get an answer, etc.

- ① Enter “Position Report” in DSC menu.

```
<DSC Menu> ⇄ <Position Report>
(Push [MENU]) (Rotate [SELECTOR], then push [ENT].)
```

- ② Rotate [SELECTOR] to select the desired pre-programmed individual address or “Manual InPut,” push [ENT].

- The ID code can be set in advance. (p. 16)
- When “Manual InPut” is selected, set the 9-digit MMSI number for the individual you wish to call with the keypad.

```
--DSC Menu--
Select Address
Manual InPut
John
→Paul
George
<CLR>Exit / <ENT>OK
```

/// When a GPS receiver (NMEA0183 ver. 2.0 or 3.01) is connected, next steps ③ and ④ (Current position/time programming) do not appear. Go to step ⑤.

- ③ The position information appears. Edit your position data (latitude and longitude) directly with the keypad. (p. 18)
- ④ After editing the position data, push [ENT] to set. Then set the current UTC time directly with the keypad, push [ENT].

```
--DSC Menu--
Position Report Ready

<CLR>Exit / <ENT>OK
```

- ⑤ Push [ENT] to transmit the Position Report call.
- If Channel 70 is busy, the transceiver stands by until the channel becomes clear.
- ⑥ After the Position Report call has been transmitted, the following indication is displayed.

```
Position Report
TX Complete
Now Waiting for ACK
<CLR>Exit
```

- ⑦ Push [CLR] to return to the previous indication before entering the DSC menu.
- Even if [CLR] hasn't been pushed, the display automatically returns to the previous indication after 2 sec. of inactivity.

6 DSC OPERATION

◆ Transmitting a Polling Request call

Transmit a Polling Request call when you want to know a specific vessel is within communication range.

- ① Enter "Polling Request" in DSC menu.

```
<DSC Menu> ⇨ <Polling Request>
(Push [MENU]) (Rotate [SELECTOR], then push [ENT].)
```

- ② Rotate [SELECTOR] to select the desired pre-programmed individual address or "Manual InPut," push [ENT].

- The ID code can be set in advance. (p. 16)
- When "Manual InPut" is selected, set the 9-digit MMSI number for the individual you wish to call with the keypad.

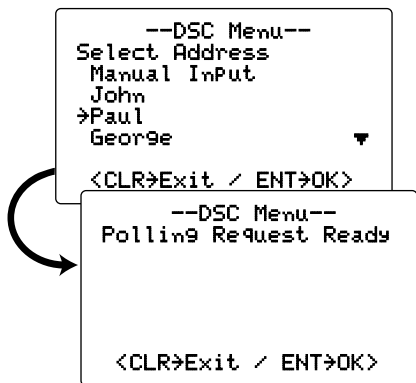

- ③ Push [ENT] to transmit the Polling Request call.
- ④ After the Polling Request call has been transmitted, the following indication is displayed.

```
Polling Request
TX Complete
Now Waiting for ACK
<CLR>Exit>
```

- ⑤ Push [CLR] to return to the previous indication before entering DSC menu.
 - Even if [CLR] hasn't been pushed, the display automatically returns to the previous indication after 2 sec. of inactivity.

◆ Transmitting a Position Reply call

Transmit a Position Reply call when a Position Request call is received.

- ① Enter “Position Reply” in DSC menu.

```

<DSC Menu> ⇄ <Position Reply>
(Push [MENU])      (Rotate [SELECTOR], then push [ENT].)
  
```

- ② Rotate [SELECTOR] to select the desired individual address or ID code, push [ENT].

When a GPS receiver (NMEA0183 ver. 2.0 or 3.01) is connected, next steps ③ and ④ (Current position/time programming) do not appear. Go to step ⑤.

- ③ The position information appears. Edit your position data (latitude and longitude) directly with the keypad. (p. 18)
- ④ After editing the position data, push [ENT] to set. Then edit the current UTC time directly with the keypad, push [ENT].

```

--DSC Menu--
Position Reply Ready

<CLR>Exit / ENT>OK>
  
```

- ⑤ Push [ENT] to transmit the Position Reply call to the selected station.
 - Your position data is transmitted, when [ENT] is pushed.

◆ Transmitting a Position Report Reply call

Transmit a Position Report Reply call when a Position Report call is received.

- ① Enter “POS Report Reply” in DSC menu.

```

<DSC Menu> ⇄ <POS Report Reply>
(Push [MENU])      (Rotate [SELECTOR], then push [ENT].)
  
```

- ② Rotate [SELECTOR] to select the desired individual address or ID code, push [ENT].
- ③ Push [ENT] to transmit the Position Report Reply call to the selected station.

◆ Transmitting a Polling Reply call

Transmit a Polling Reply call when a Polling Request call is received.

- ① Enter “Polling Reply” in DSC menu.

```

<DSC Menu> ⇄ <Polling Reply>
(Push [MENU])      (Rotate [SELECTOR], then push [ENT].)
  
```

- ② Rotate [SELECTOR] to select the desired individual address or ID code, push [ENT].
- ③ Push [ENT] to transmit the Polling Reply call to the selected station.

■ Receiving DSC calls

◇ Receiving a Distress call

While monitoring Channel 70 and a distress call is received:

- The emergency alarm sounds for 2 minutes after receiving the first distress call from a station.
 - Push [CLR] to stop the alarm.
 - After receiving a second (or repeated) distress call from the same station, the alarm sounds for 1 sec.
- “Received Distress” appears in the display, then Channel 16 is automatically selected.
- Continue monitoring Channel 16 as a coast station may require assistance.

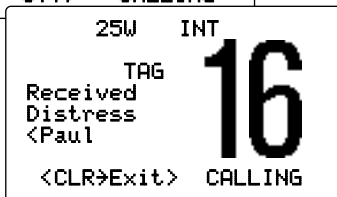
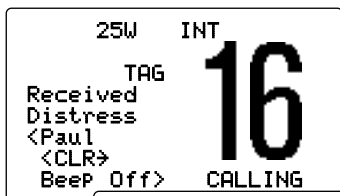

◇ Receiving a Distress Acknowledgement

While monitoring Channel 70 and a Distress acknowledgement to other ship is received:

- The emergency alarm sounds for 2 minutes.
 - Push [CLR] to stop the alarm.
- “Received DistressACK” appears in the display, then Channel 16 is automatically selected.

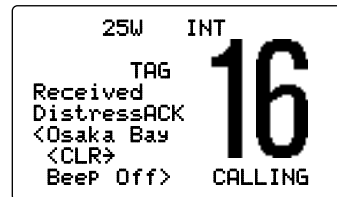

◇ Receiving a Distress Relay call

While monitoring Channel 70 and a Distress Relay acknowledgement is received:

- The emergency alarm sounds for 2 minutes.
 - Push [CLR] to stop the alarm.
- “Received DistressRLY” appears in the display, then Channel 16 is automatically selected.

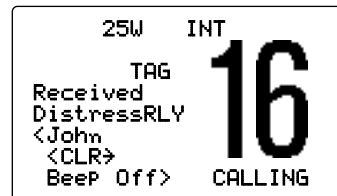

◆ Receiving an Individual call

While monitoring Channel 70 and an Individual call is received:

- ➔ The emergency alarm or beeps sound depending on the received category.
- ➔ “Received Individual” appears in the display.
- ➔ Push [CLR] to stop beep, then push [ENT] to reply the call and select the channel specified by the calling station for voice communication (depending on your replying condition see p. 25 for individual acknowledgement call procedure for details.); push [CLR] to ignore the Individual call.

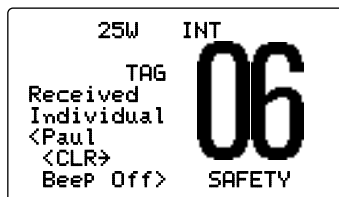

◆ Receiving a Group call

While monitoring Channel 70 and a Group call is received:

- ➔ The emergency alarm or beeps sound depending on the received category.
- ➔ “Received Group” appears in the display.
- ➔ Push [CLR] to stop beep, then push [ENT] to select the channel specified by the calling station for voice communication; push [CLR] to ignore the Group call.

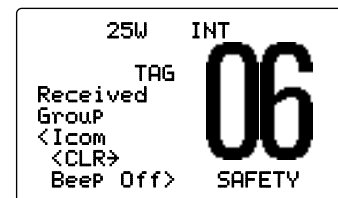

◆ Receiving an All Ships call

While monitoring Channel 70 and an All Ships call is received:

- ➔ The emergency alarm sounds when the category is 'Distress' or 'Urgency'; 2 beeps sound for other categories.
- ➔ “Received All Ships” appears in the display.
- ➔ Push [CLR] to stop beep, then push [ENT] to monitor channel 16 for an announcement from the calling vessel, push [CLR] to ignore the call.

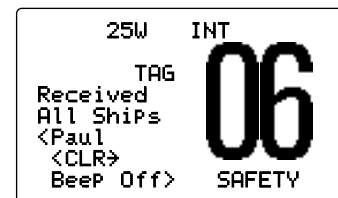

6 DSC OPERATION

◆ Receiving a Geographical Area call

While monitoring Channel 70 and a Geographical Area call (for the area you are in) is received:

- Emergency alarm or beeps sound depending on the received category.
- “Received GeographiC” appears in the display.

```
25W INT
TAG
Received
GeographiC
<Osaka Bay
<CLR>
Beep Off> 06 SAFETY
```

- Push [CLR] to stop the beep, then push [ENT] to change to the channel specified by the calling station for voice communication; push other key to ignore the Geographical Area call.
- Monitor the selected channel for an announcement from the calling station.

▨ When no GPS receiver is connected or if there is a problem with the connected receiver, all Geographical Area calls are received, regardless of your position.

◆ Receiving a Position Request call

While monitoring Channel 70 and a Position Request call is received:

- “Received POS Request” appears in the display.
- Push [CLR] to stop the beep, then push [ENT] to reply to the call; push [CLR] to ignore the call.

```
25W INT
TAG
Received
POS Request
<Paul
<CLR>
Beep Off> 06 SAFETY
```

◆ Receiving a Position Report call

While monitoring Channel 70 and a Position Report call is received:

- “Received POS Report” appears in the display.
- Push [CLR] to stop the beep, then push [ENT] to reply to the call; push [CLR] to ignore the call.
 - After transmitting a reply call, push [ENT] to display the position information, or push [CLR] to exit the condition.

```
25W INT
TAG
Received
POS Report
<Paul
<CLR>
Beep Off> 06 SAFETY
```

◇ Receiving a Polling Request call

While monitoring Channel 70 and a Polling Request call is received:

- ➔ “Received POLL REQ” appears in the display.
- ➔ Push [CLR] to stop the beep, then push [ENT] to reply to the call; push [CLR] to ignore the call.



◇ Receiving a Position Reply call

While monitoring Channel 70 and a Position Reply call is received:

- ➔ “Received POS RePly” appears in the display.
- ➔ Push [CLR] to stop the beep, then push [ENT] to display the position information; push [CLR] to ignore the reply call.



◇ Receiving a Position Report Reply call

While monitoring Channel 70 and a Position Report Reply call is received:

- ➔ “Received POS RePly” appears in the display.
- ➔ Push [CLR] to stop the beep, then push [ENT] to display the position information; push [CLR] to ignore the reply call.

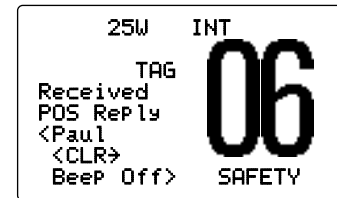

◇ Receiving a Polling Reply call

While monitoring Channel 70 and a Polling Reply call is received:

- ➔ “Received POLL RePly” appears in the display.
- ➔ Push [CLR] to stop the beep, then push [CLR] again to exit the condition.

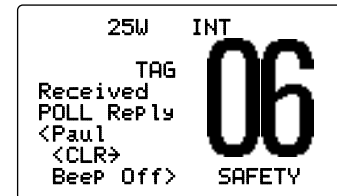

Received messages

The transceiver automatically stores up to 20 distress messages and 20 other messages. The messages can be used as an assistance to the logbook.

Distress message

- Enter "Distress" in DSC menu.

```
<DSC Menu> ⇨ <Received Calls> ⇨ <Distress>
(Push [MENU]) (Rotate [SELECTOR], then push [ENT].)
```

- Rotate [SELECTOR] to select the desired message, push [ENT].

- Messages which are blinking have not been read.

```
--DSC Menu--
Select Message
->12:15 John
04:13 George
<CLR>Exit / ENT>OK
```

- Rotate [SELECTOR] to scroll the selected message.



```
--DSC Menu--
Distress
<John
Explosion
LAT: 12°34.567N
LON: 123°45.678W
<CLR>Exit / CE>Del
```

- Push [CLR] to exit the condition or push [CE] to clear the displayed message and returns to DSC menu.

Other messages

- Enter "Other" in DSC menu.

```
<DSC Menu> ⇨ <Received Calls> ⇨ <Other>
(Push [MENU]) (Rotate [SELECTOR], then push [ENT].)
```

- Rotate [SELECTOR] to scroll to the desired message, push [ENT].

- Messages which are blinking have not read.

```
--DSC Menu--
Select Message
->Individual Call
Group Call
Position Replay
All Ships Call
<CLR>Exit / ENT>OK
```

- Rotate [SELECTOR] to scroll the message.

- The stored message has various information and depending on the type of Distress call.

```
--DSC Menu--
Individual Call
<Paul
Routine
F3E simplex
CH08
<CLR>Exit / CE>Del
```

- Push [CLR] to exit the condition or push [CE] to clear the displayed message and returns to DSC menu.

■ DSC Set mode

◇ Add Individual ID/Group ID (See pgs. 16, 17)

◇ Delete Individual ID/Group ID (See p. 17)

◇ MMSI Code Check

The programmed 9-digit MMSI (DSC self ID) code can be checked in DSC Set mode.

① Enter “MMSI Check” in DSC Set up menu.

```
<DSC Menu> ⇄ <Set up> ⇄ <MMSI Check>
(Push [MENU]) (Rotate [SELECTOR], then push [ENT].)
```

② Check the 9-digit MMSI (DSC self ID) code.

```
--DSC Menu--
MMSI Check
123456789

<CLR>Exit>
```

③ Push [CLR] to exit the condition to DSC set up menu.

④ Push [CLR] or rotate [SELECTOR] to select “Exit,” push [ENT] to return to the DSC menu.

- Repeat again to return to the normal operation condition.

◇ Automatic Acknowledgement

This item sets the automatic acknowledgement function to ON or OFF.

When a position request, position report or polling request call is received, the transceiver automatically transmits a position request reply, position report reply or polling reply call, respectively.

① Enter “Auto ACK” in DSC menu.

```
<DSC Menu> ⇄ <Set up> ⇄ <Auto ACK>
(Push [MENU]) (Rotate [SELECTOR], then push [ENT].)
```

② Rotate [SELECTOR] to turn the automatic acknowledgement function ON or OFF.

```
--DSC Menu--
Auto ACK
ON
→OFF

<CLR>Exit / ENT>OK>
```

③ Push [ENT] to set and to exit the condition to DSC set up menu.

④ Push [CLR] or rotate [SELECTOR] to select “Exit,” push [ENT] to return to the DSC menu.

- Repeat again to return to the normal operation condition.

6 DSC OPERATION

◆ Offset Time

This item sets the offset time from the UTC (Universal Time Coordinated) time.

- 1 Enter "Offset Time" in DSC Set up menu.

```
<DSC Menu> ⇄ <Set up> ⇄ <Offset Time>
(Push [MENU]) (Rotate [SELECTOR], then push [ENT].)
```

- 2 Set the offset time from the UTC (Universal Time Coordinated) time.
 - Edit the digit of offset time directly with the keypad.
 - Push [0•-./] to edit "-" or "+", when the cursor is on the first digit.
 - Rotate [SELECTOR] to move the cursor backward or forward.
 - Push [CE] to clear the time data.
 - Push [CLR] to cancel and exit the condition to DSC set up menu.

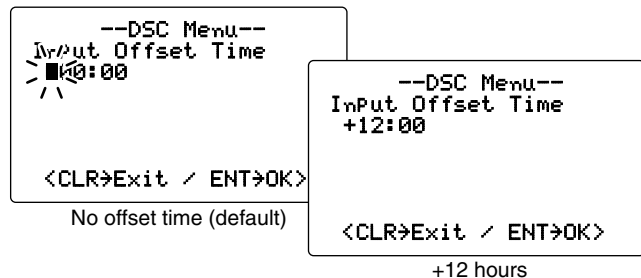

- 3 Push [ENT] to set and to exit the condition to DSC set up menu.
- 4 Push [CLR] or rotate [SELECTOR] to select "Exit," push [ENT] to return to the DSC menu.
 - Repeat again to return to the normal operation condition.

◆ NMEA Output

Select an NMEA Output function from List Station, All Station or OFF.

When receiving position acknowledgment, the transceiver outputs it to the external equipment via the NMEA connector.

- 1 Enter "NMEA OutPut" in DSC menu.

```
<DSC Menu> ⇄ <Set up> ⇄ <NMEA OutPut>
(Push [MENU]) (Rotate [SELECTOR], then push [ENT].)
```

- 2 Rotate [SELECTOR] to select the NMEA Output function from List Station, All Station or OFF.
 - List Station : Outputs the position data from the specified vessels listed on the DSC individual ID screen.
 - All Station : Outputs the position data from all vessels.
 - OFF : Outputs no position data to external equipment.



- 3 Push [ENT] to set and to exit the condition to DSC set up menu.
 - Push [CLR] to cancel and exit the condition to DSC set up menu.
- 4 Push [CLR] or rotate [SELECTOR] to select "Exit," push [ENT] to return to the DSC menu.
 - Repeat again to return to the normal operation condition.

■ Intercom operation

The optional intercom function allows you to talk to the deck from the cabin. The optional COMMANDMICIII™ is required for intercom operation.

Connect the COMMANDMICIII™ as described on p. 51.

- Up to two COMMANDMICIII™s can be connected simultaneously.
- Transmitting is impossible during intercom operation.
- The received signal is muted during intercom operation.

- ① Push **[F]**, then push **[9•IC]** to enter intercom mode.
 - The COMMANDMICIII™ power is automatically turned ON, even if the power is OFF.

When the connected COMMANDMICIII™ is one, step ② does not appear. Go to step ③.

- ② Select the desired intercom party, transceiver (RADIO) or COMMANDMICIII™ (INTERCOM), then push **[ENT]***.

* Push **[IC]** from the HM-162E.

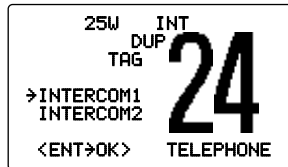

IC-M603

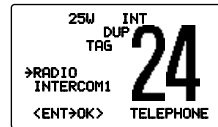

HM-162E

Select within 5 sec. from entering intercom mode.

NOTE: The COMMANDMICIII™, connected to the [COMMAND MIC-1] connector, is recognized as 'INTERCOM1,' and the other side is 'INTERCOM2.'

- ③ Push and hold **[9•IC]** for more than 1 sec. to emit the intercom beep while holding.
 - The transceiver and the COMMANDMICIII™ emit beeps.
- ④ Push and hold **[PTT]** and speak at a normal voice level into the microphone.
 - "TALK" or "LISTEN" appears on the caller or listener function display, respectively.
 - "WAIT" appears if it is idle.
 - To adjust the IC-M603's speaker output level, rotate **[VOL]**.
 - To adjust the HM-162E's speaker output level, rotate **[SELECTOR]**.

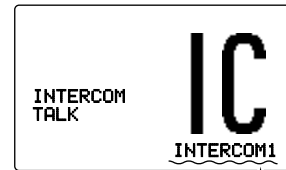

IC-M603 (caller)

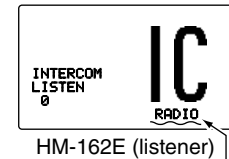

HM-162E (listener)

The connected intercom party is displayed here.

- ⑤ After releasing **[PTT]** you can hear the response through the speaker.
- ⑥ To return to normal operation, push **[CLR]** or repeat step ①.

7 OTHER FUNCTIONS



- While in the intercom mode, the transceiver functions (transmit and receive) are interrupted. If the transceiver is in transmit condition, the intercom function is not available.
- When a DSC call is received, the intercom function is interrupted with an automatic return to the transceiver mode. The transceiver's display indicates 'Receiving DSC calls.' (p. 32)

■ Hailer operation

The IC-M603 has a 2-way hailer function for voice amplification and reception over a loudspeaker, making it unnecessary to leave the bridge to hear a hailing party. During hailer operation, transmitting is impossible and the received signal is muted.

Connect an external hailer speaker as described on p. 46.

- ① Push **[F]**, then push **[7•HAIL]** to enter hailer mode.

Push ,
then push 





- ② Push and hold **[PTT]** and speak at a normal voice level into the microphone.
 - "TALK" or "LISTEN" appears on the caller or listener function display, respectively.
 - To adjust the hailer level, rotate **[SELECTOR]**.
- ③ After releasing **[PTT]** you can hear the response through the speaker.
- ④ To return to normal operation, push **[CLR]** or repeat step ①.

- While in the hailer mode, the transceiver functions (transmit and receive) are interrupted. If the transceiver is in transmit condition, the hailer function is not available.
- When a DSC call is received, the hailer function is interrupted with an automatic return to the transceiver mode. The transceiver's display indicates 'Receiving DSC calls.' (p 32)

■ Automatic foghorn

The automatic foghorn function sounds a horn repeatedly until the function is turned OFF. Four patterns are available for varying conditions.

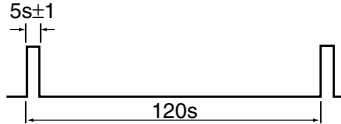
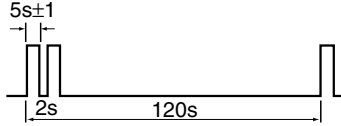
The foghorn outputs from the hailer speaker. To use this function, the hailer speaker must be connected to the transceiver. See p. 46 for connection details.

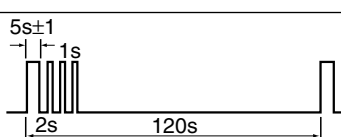
TYPE	PATTERN	USAGE
UNDERWAY	One 5-second blasts every 120 seconds. 	Motor vessel underway and making way.
STOP	Two 5-second blasts (separated by 2 seconds) every 120 seconds. 	Motor vessel underway but stopped (not making way).
SAIL	One 5-second blast followed by two 1-second blasts (each separated by 2 seconds) every 120 seconds. 	Sailing vessel underway, fishing vessel (underway or anchored), vessel not under command, a vessel restricted in her ability to maneuver (underway or at anchor), or a vessel towing or pushing another ahead.
TOW	One 5-second blast followed by three 1-second blasts (each separated by 2-seconds) every 120 seconds. 	Vessel under tow (manned).

/// The audio frequency of the foghorn is selectable. See p. 44 for details on selecting the audio frequency.

7 OTHER FUNCTIONS

- ① Push **[F]**, then push **[8•FOG]** to enter auto foghorn mode.

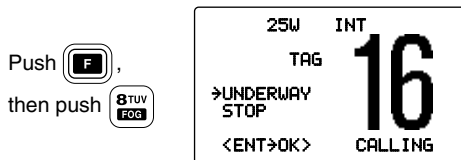

- ② Rotate **[SELECTOR]** to select the desired foghorn pattern, push **[ENT]**.
 - ‘UNDERWAY,’ ‘STOP,’ ‘SAIL,’ ‘TOW’ are available. (p. 41)
 - Even if **[ENT]** hasn’t been pushed, the display automatically changes to the next step after about 5 sec. of inactivity.
- ③ Rotate **[SELECTOR]** to adjust the foghorn level, push **[ENT]**.
 - The foghorn level is adjustable in 31 steps.
 - Even if **[ENT]** hasn’t been pushed, the display automatically changes to the next step after about 5 sec. of inactivity.

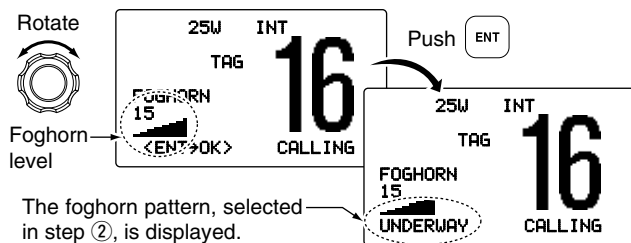

- ④ To return to normal operation, repeat step ①.

When a DSC call is received, the automatic foghorn function is interrupted with an automatic return to the transceiver mode. The transceiver’s display indicates ‘Receiving DSC calls.’ (p. 32)

■ RX speaker function

The IC-M603 has an RX speaker function. When this function is turned ON, the received audio can be heard on the deck or tower via a hailer speaker.

Connect a hailer speaker as described on p. 46.

- ① Push **[F]**, then push and hold **[7•HAIL]** for 1 sec. to enter the RX Speaker mode.
 - “RX ◀▶” appears.



- ② Rotate **[SELECTOR]** to adjust the audio output level, push **[ENT]**.
- ③ To return to normal operation, repeat step ①.

While in the RX speaker mode, rotate **[SELECTOR]** while pushing and holding **[7•HAIL]** after pushing **[F]**, to adjust the audio output level. After adjusting, push **[ENT]**.

- Rotate **[SELECTOR]** within 1 sec. after pushing **[7•HAIL]**. Otherwise the transceiver returns to the normal operation.

■ Set mode programming

Set mode is used to change the conditions of the transceiver's functions: Scan type*¹, Scan resume timer*¹, Beep tone, Internal speaker, LCD contrast, Automatic foghorn frequency, Radio power*², Scrambler type*³, Scrambler code*³ and Favorite channel.

*¹Except for Holland version.

*²Appears only when an optional COMMANDMICIII™ is connected.

*³Appears only when an optional scrambler unit is installed.

/// Available functions may differ depending on dealer setting.

- ① While pushing and holding [**16**•**C**], push [**POWER**] to enter Set mode.
 - Turn power OFF in advance.
- ② After the display appears, release [**16**•**C**].
- ③ Rotate [**SELECTOR**] to select the desired item, push [**ENT**].
- ④ Rotate [**SELECTOR**] to select the desired condition of the item, push [**ENT**] to set.
- ⑤ Push [**CLR**], or rotate [**SELECTOR**] to select "Exit" then push [**ENT**] to exit Set mode and returns to normal condition.

• SET MODE CONSTRUCTION

Rotate



```

--Set Mode--
→Scan Type
Scan Timer
Beep
Internal Speaker
Contrast
Foghorn Frequency
Radio Power
Scrambler Type
Scrambler Code
Favorite CH
Exit
    
```

■ Set mode items

◇ Scan type (Except for Holland version)

The transceiver has 2 scan types: normal scan and priority scan. Normal scan searches all TAG channels in the selected channel group. Priority scan searches all TAG channels in sequence while monitoring Channel 16.

```

--Set Mode--
Scan Type
Priority
→Normal
    
```

(Default: Normal)

◇ Scan resume timer (Except for Holland version)

The scan resume timer can be selected as a pause (OFF) or timer scan (ON). When OFF is selected, the scan pauses until the signal disappears. When ON is selected, the scan pauses 5 sec. and resumes even if a signal has been received on any other channel than Channel 16.

```

--Set Mode--
Scan Timer
ON
→OFF
    
```

(Default: OFF)

8 SET MODE

◆ Beep tone

You can select silent operation by turning beep tones OFF, or you can have confirmation beeps sound at the push of a key by turning beep tones ON.

```
--Set Mode--  
Beep  
➤ON  
OFF
```

(Default: ON)

◆ Internal speaker

When an external speaker is connected and the transceiver's internal speaker is not required, the speaker of the transceiver and the connected microphone can be deactivated.

```
--Set Mode--  
Internal Speaker  
➤ON  
OFF
```

(Default: ON)

◆ LCD contrast

This item adjusts the contrast of the LCD in 8 steps.

```
--Set Mode--  
Contrast  
➤5  
4  
3  
2  
  
<CLR>Exit / ENT>OK>
```

(Default: 5)

◆ Automatic foghorn frequency

The audio frequency of the automatic foghorn can be adjusted to suit your preference. While this item is selected, pushing [PTT] outputs the foghorn— experiment with the frequencies available until you find one you like.

• Available frequency range is 200 Hz to 850Hz in 50 Hz step.

```
--Set Mode--  
Foghorn Frequency  
➤400  
350  
300  
250  
  
<CLR>Exit / ENT>OK>
```

(Default: 400)

◆ Radio power

(Appears when a COMMANDMICIII™ is connected)

This item sets the Radio power function ON or OFF.

ON : The transceiver's power is controlled by the optional command microphone. When the command microphone is turned OFF, the transceiver will also be turned OFF automatically.

OFF : The transceiver's power is not controlled by the optional command microphone. Even if the command microphone is turned OFF, the transceiver will continue to work.

```
--Set Mode--  
Radio Power  
➤ON  
OFF
```

(Default: ON)

◆ Scrambler type

(Appears when a scrambler unit is installed)

When an optional scrambler unit is installed, the scrambler type can be selected in Set mode depending on dealer setting.

```

--Set Mode--
Scrambler Type
UT-98
➔UT-112
    
```

(Default: UT-112)

◆ Scrambler code

(Appears when a scrambler unit is installed)

When an optional scrambler unit is installed, the scrambler code can be set depending on dealer setting.

When the UT-112 is installed, 32 codes (1 to 32) can be selected.

When the UT-98 is installed, 128 codes (0 to 127) can be selected.

When UT-112 is installed

```

--Set Mode--
Scrambler Code
4
3
2
➔1
<CLR>Exit / ENT>OK>
    
```

(Default: 1)

When UT-98 is installed

```

--Set Mode--
Scrambler Code
3
2
1
➔0
<CLR>Exit / ENT>OK>
    
```

(Default: 0)

◆ Favorite channel

This item sets the Favorite channel function ON or OFF.

The favorite channel is programmed by the TAG channel setting (p. 15).

ON : [▲]/[▼] keys on the microphone select the favorite channels in the selected channel group in sequence when pushed.

OFF : [▲]/[▼] keys on the microphone select all channels in the selected channel group in sequence when pushed.

```

--Set Mode--
Favorite CH
➔ON
OFF
    
```

(Default: ON)

9

CONNECTIONS AND MAINTENANCE

■ Connections

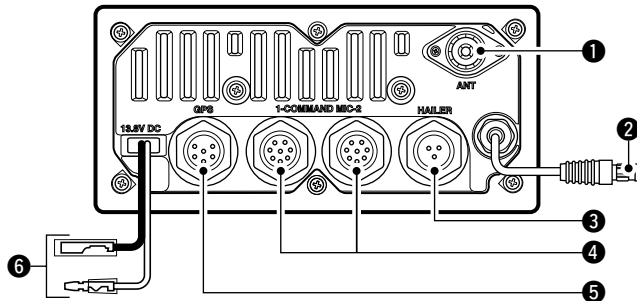

1 ANTENNA CONNECTOR

Connects a marine VHF antenna with a PL-259 connector to the transceiver.

CAUTION: Transmitting without an antenna will damage the transceiver.

2 MICROPHONE CONNECTOR

Connect the supplied microphone only.

CAUTION: NEVER connect other microphones here, such as the optional HM-162E, for they may cause damage to the transceiver.

3 HAILER/FOGHORN CONNECTOR

Connects a hailer speaker (30 W nominal at 13.8 V/ 4 Ω).



4 EXTERNAL MICROPHONE CONNECTORS [COMMAND MIC-1]/[COMMAND MIC-2]

Connects the optional COMMANDMICIII™ (HM-162E.)

CAUTION: NEVER connect other microphone here, such as the HM-134, may cause damage to the transceiver.

5 GPS RECEIVER/EXTERNAL SPEAKER CONNECTOR

Connects a GPS receiver for position and time indications.

- An NMEA0183 ver. 2.0 or 3.01 (sentence formatters RMC, GGA, GNS, GLL) compatible GPS receiver is required. Ask your dealer about suitable GPS receivers.



Transceiver's rear panel view

Connects a PC or navigation equipment (NMEA0183 ver. 3.01 sentence formatters DSC, DSE compatible) for plotting received other ships position data.

Connects an external speaker.

NOTE: Attach the supplied connector covers to 2, 3, 4 or 5 when they are not in use.

6 DC POWER CONNECTOR

Connects the supplied DC power cable from this connector to an external 13.8 V DC power source.

CAUTION: After connecting the DC power cable, cover the connectors with a rubber vulcanising tape as shown below, to prevent water seeping into the transceiver.

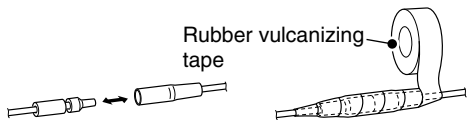

■ Antenna

A key element in the performance of any communication system is an antenna. Ask your dealer about antennas and the best place to mount them.

■ Fuse replacement

One fuse is installed in the supplied DC power cable. If a fuse blows or the transceiver stops functioning, track down the source of the problem, if possible, and replace the damaged fuse with a new, rated one.

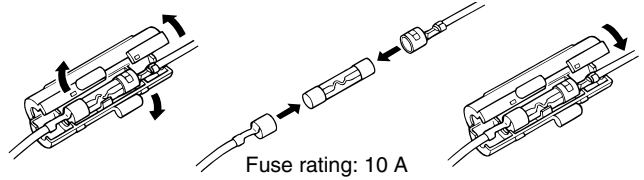

■ Supplied accessories

The following accessories are supplied

<p>Mounting bracket</p>	<p>For mounting bracket</p> <p>Knob bolts </p> <p>Flat washers (M5) </p> <p>Screws (5×20) </p> <p>Spring washers (M5) </p>	
<p>Microphone</p>	<p>Accessory connectors (3 pin, 6 pin)</p>	<p>DC power cable</p>
<p>Sponges</p>	<p>Microphone hanger and screws (3×16)</p>	<p>Microphone hanger cable*</p>

*Depending on version

■ Microphone hanger

Rest the supplied microphone on the hanger when not in use. Connect the microphone hanger cable* to the transceiver's ground terminal with a self-tapping screw (3 × 8 mm) and the other side to the microphone hanger to use the microphone hanger function.

- *Depending on version.
- If the microphone hanger function is used, Channel 16 is selected automatically when the supplied microphone is rested on the hanger.

■ Mounting the transceiver

◆ Using the supplied mounting bracket

The universal mounting bracket supplied with your transceiver allows overhead or onboard mounting.

- Mount the transceiver securely with the 4 supplied screws (M5 × 20) to a surface which is more than 10 mm thick and can support more than 5 kg.
- Mount the transceiver so that the face of the transceiver is at 90° to your line of sight when operating it.

CAUTION: KEEP the transceiver and microphone at least 1 meter away from your vessel's magnetic navigation compass.

NOTE:

- Check the installation angle; the function display may not be easy-to-read at some angles.
- When mounting the transceiver on the place that is prone to strong vibration, use the supplied sponges between the transceiver and mounting bracket for reducing the effect of the vibration.

• OVERHEAD MOUNTING

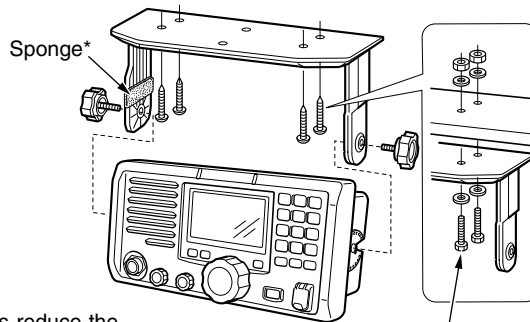

*Sponges reduce the vibration effects. See NOTE at left.

These screws are shown a mounting example only. Not supplied with accessories.

• MOUNTING ON THE BOARD

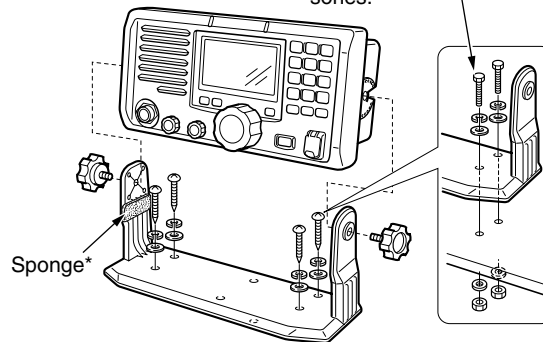

■ MB-75 installation

An optional MB-75 FLUSH MOUNT KIT is available for mounting the transceiver to a flat surface such as an instrument panel.

CAUTION: KEEP the transceiver and microphone at least 1 meter away from your vessel's magnetic navigation compass.

- ① Using the attached template, carefully cut a hole into the instrument panel (or wherever you plan to mount the transceiver).
- ② Slide the transceiver through the hole as shown below.

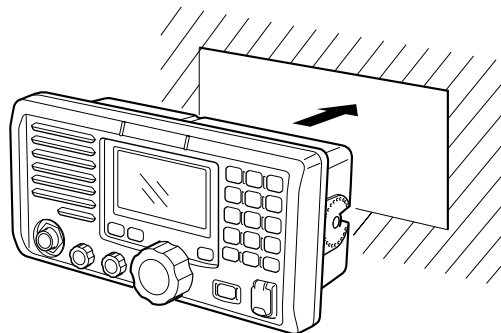

- ③ Attach the 2 supplied bolts (M5 × 8 mm) on either side of the IC-M603.

- ④ Attach the clamps on either side of the IC-M603.
 - Make sure that the clamps align parallel to the IC-M603's body.

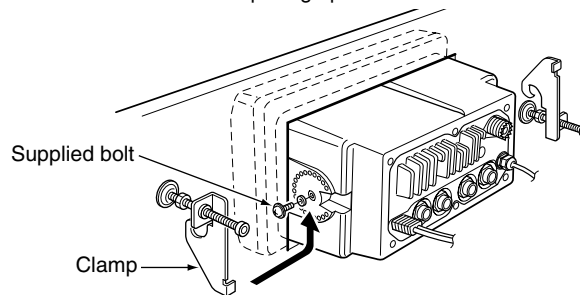

- ⑤ Tighten the end bolts on the clamps (rotate clockwise) so that the clamps press firmly against the inside of the instrument control panel.
- ⑥ Tighten the locking nuts (rotate counterclockwise) so that the IC-M603 is securely mounted in position as below.

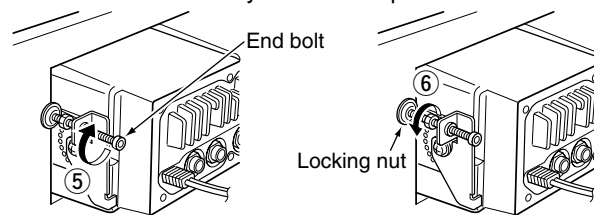

- ⑦ Connect the antenna and power cable, then return the instrument control panel to its original place.

Optional unit installation

CAUTION: DISCONNECT the DC power cable from the transceiver before performing any work on the transceiver. Otherwise, there is danger of electric shock and/or equipment damage.

See the following the case disassembly procedure when you want to install an optional unit.

- ① Remove the 12 screws and open the transceiver.
- ② Turn the transceiver upside down, then disconnect the 3 flat cables and Rear mic connector (6-pin) from LOGIC board, and Front mic connector (2-pin) and Volume connector (3-pin) from AF board.

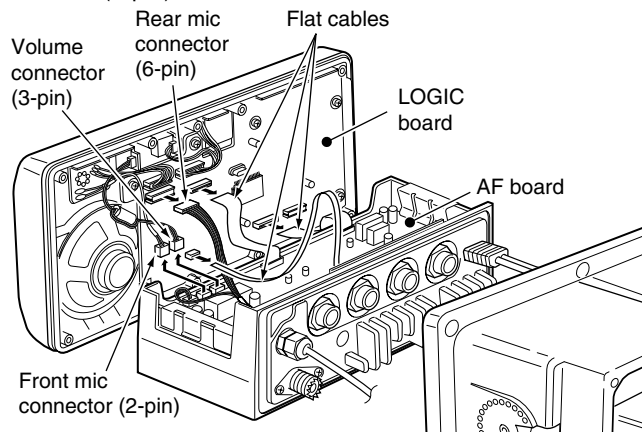

- ③ Install an optional unit to J3 on the AF board as shown below.

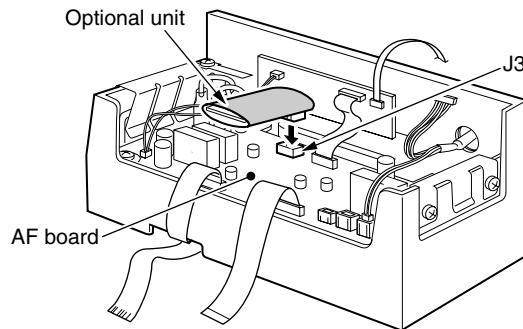

- ④ Assemble the units to their original positions.

CAUTION:

- Tighten the screws with the specified torque (0.7 N.m) when assembling the transceiver. Otherwise the transceiver may be damaged (torque too high) or lose waterproof efficiency (torque too low).
- When unistalling the optional unit, remove it vertically. Wiggling the unit from side to side may damage the optional unit's connector.

■ HM-162E installation

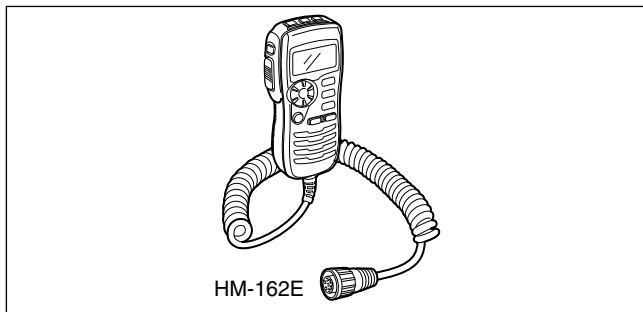

The optional HM-162E should be installed to the transceiver using the supplied connection cable. The connector of the connection cable can be installed into a cabinet, wall, etc., as a built-in plug.

For longer distance remote operation, the optional extension cable, OPC-1541 (6 m; connecting between transceiver and the connection cable), is available, and up to two OPC-1541 can be added.

Do not connect the HM-162E to the OPC-1000.

- ① Insert the supplied cable into the [COMMAND MIC-1] or [COMMAND MIC-2] connector and tighten the cable nut as shown below.
 - Up to two COMMANDMICIII™s can be connected simultaneously.

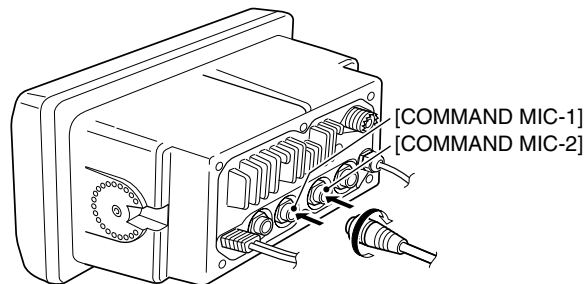

- ② To use the supplied cable as a wall socket, perform the following steps.
- ③ Using the mounting base as a template, carefully mark the holes where the cable and three screws will be fastened.
- ④ Drill holes at these marks.
- ⑤ Install the mounting base using the supplied screws as shown below.

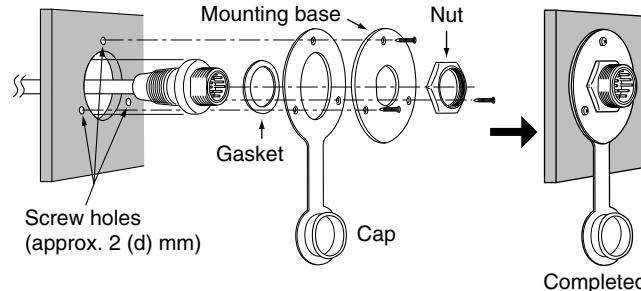

9 CONNECTIONS AND MAINTENANCE

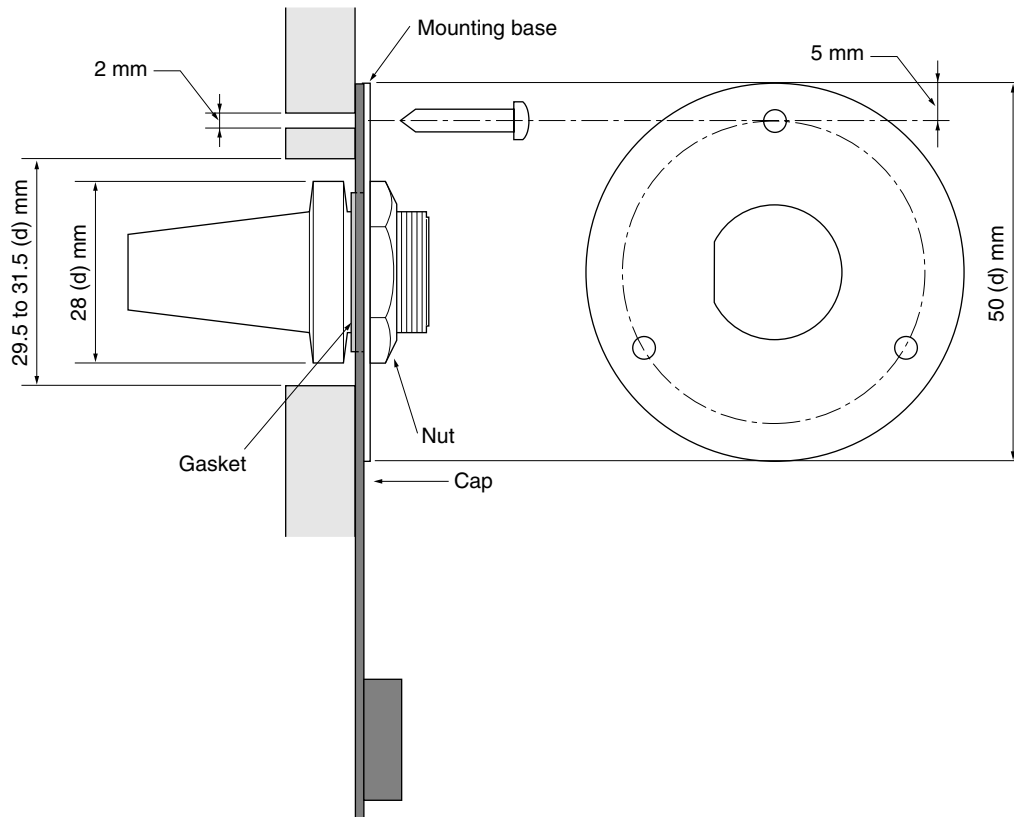

PROBLEM	POSSIBLE CAUSE	SOLUTION	REF.
The transceiver does not turn ON.	<ul style="list-style-type: none"> • Bad connection to the power supply. 	<ul style="list-style-type: none"> • Check the connection to the transceiver. 	pgs. 46, 47
No sound from speaker.	<ul style="list-style-type: none"> • Squelch level is too high. • Volume level is too low. • Speaker has been exposed to water. • Internal speaker is turned OFF. 	<ul style="list-style-type: none"> • Set [SQL] to the threshold point. • Set [VOL] to a suitable level. • Drain water from the speaker. • Turn the internal speaker ON in Set mode. 	<p>p. 9</p> <p>p. 9</p> <p>p. 11</p> <p>p. 44</p>
Transmitting is impossible, or high power cannot be selected.	<ul style="list-style-type: none"> • Some channels are programmed for low power or receive only in regulations. • The output power is set to low. 	<ul style="list-style-type: none"> • Change channels. • Push [H/L] to select high power. 	<p>pgs. 7, 8, 57</p> <p>p. 9</p>
Scan does not start.	<ul style="list-style-type: none"> • TAG channel is not programmed. 	<ul style="list-style-type: none"> • Set the desired channels as TAG channels. 	p. 15
No beeps.	<ul style="list-style-type: none"> • Beep tones are turned OFF. • The squelch is open. 	<ul style="list-style-type: none"> • Turn the beep tone ON in Set mode. • Set [SQL] to the threshold point. 	<p>p. 44</p> <p>p. 9</p>
Receive signal cannot be understood.	<ul style="list-style-type: none"> • Optional voice scrambler is turned OFF. • Scramble code is not set correctly. 	<ul style="list-style-type: none"> • Turn the optional voice scrambler ON. • Reset the scramble code. 	<p>pgs. 12, 45</p>
Distress call cannot be transmitted.	<ul style="list-style-type: none"> • MMSI (DSC self ID) code is not programmed. 	<ul style="list-style-type: none"> • Program the MMSI (DSC self ID) code. 	p. 16

■ Specifications

◇ General

- Frequency coverage : TX 156.000–161.450 MHz
RX 156.000–163.425 MHz
- Mode : FM (16K0G3E), DSC (16K0G2B)
- Current drain (at 13.8 V) : TX high (25 W) 5.5 A
Max. audio 1.5 A
- Power supply requirement : 13.8 V DC (10.8 to 15.6 V)
(negative ground)
- Frequency stability : ± 5 ppm
- Operating temp. range : -20°C to $+60^{\circ}\text{C}$
- Antenna impedance : 50 Ω nominal
- Input impedance (MIC) : 2 k Ω
- Output impedance (audio) : 4 Ω
- Dimensions : 220(W) \times 110(H) \times 109.4(D) mm
(Projections not included)
- Weight : Approx. 1400 g

◇ Transmitter

- RF output power : 25 W and 1 W
- Modulation system : Variable reactance frequency
modulation
- Max. frequency deviation : ± 5.0 kHz
- Spurious emissions : Less than 0.25 μW
- Adjacent channel power : More than 70 dB
- Audio harmonic distortion : Less than 10%
(at 1 kHz, 60% deviation)
- Residual modulation : More than 40 dB
- Audio frequency response : +1 to -3 dB of 6 dB/octave
range from 300 Hz to 3000 Hz

◇ Receiver

- Receive system : Double conversion superheterodyne
- Sensitivity (20 dB SINAD) : -5 dB μ emf (typical)
 -5 dB μ emf (typical) (CH 70 receiver)
- Squelch sensitivity : -5 dB μ emf (typical)
- Spurious response : More than 75 dB
- Intermodulation : More than 75 dB
- Adjacent channel selectivity : More than 75 dB
- Hum and noise : More than 45 dB
- Audio output power : 2.0 W (typical) at 10% distortion
with a 4 Ω load

All stated specifications are subject to change without notice or obligation.

◇ Dimensions

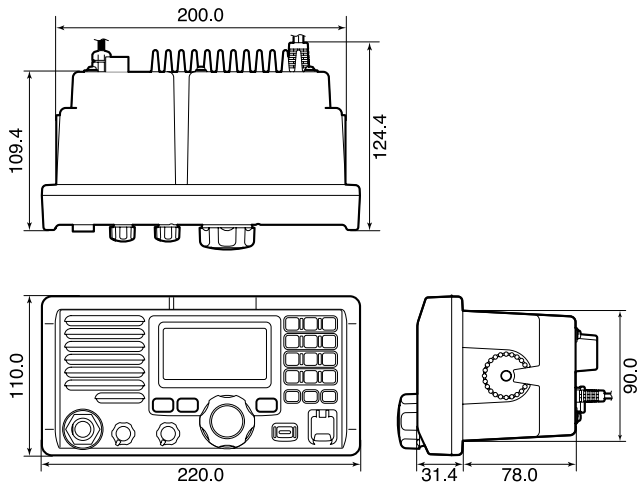

Unit: mm

■ Options

- **MB-75** FLUSH MOUNT KIT

For mounting the transceiver to a panel.

- **HM-162E** COMMANDMICIII™

External microphone-type controller. Provides optional intercom operation. 6 m microphone cable and mounting base included.

Do not connect the HM-162 to the OPC-1000.

- **OPC-1541** MICROPHONE EXTENSION CABLE

6 m microphone extension cable for optional HM-162E COMMANDMICIII™. Up to 2 OPC-1541 can be connected. (18 m maximum)

- **UT-112** VOICE SCRAMBLER UNIT

Ensures private communications. 32 codes are available. Not available in some countries.

- **OPC-1000** MICROPHONE EXTENSION CABLE

6 m microphone extension cable for the supplied microphone.

12 CHANNEL LIST

• International channels

CH	Frequency (MHz)		CH	Frequency (MHz)		CH	Frequency (MHz)		CH	Frequency (MHz)		CH	Frequency (MHz)		CH	Frequency (MHz)	
	Transmit	Receive		Transmit	Receive		Transmit	Receive		Transmit	Receive		Transmit	Receive		Transmit	Receive
01	156.050	160.650	11	156.550	156.550	21	157.050	161.650	61	156.075	160.675	71	156.575	156.575	81	157.075	161.675
02	156.100	160.700	12	156.600	156.600	22	157.100	161.700	62	156.125	160.725	72	156.625	156.625	82	157.125	161.725
03	156.150	160.750	13	156.650	156.650	23	157.150	161.750	63	156.175	160.775	73	156.675	156.675	83	157.175	161.775
04	156.200	160.800	14	156.700	156.700	24	157.200	161.800	64	156.225	160.825	74	156.725	156.725	84	157.225	161.825
05	156.250	160.850	15 ^{*2}	156.750	156.750	25	157.250	161.850	65	156.275	160.875	75 ^{*4}	156.775	156.775	85	157.275	161.875
06	156.300	156.300	16	156.800	156.800	26	157.300	161.900	66	156.325	160.925	76 ^{*4}	156.825	156.825	86	157.325	161.925
07	156.350	160.950	17 ^{*2}	156.850	156.850	27	157.350	161.950	67	156.375	156.375	77	156.875	156.875	87	157.375	157.375
08	156.400	156.400	18	156.900	161.500	28	157.400	162.000	68	156.425	156.425	78	156.925	161.525	88	157.425	157.425
09	156.450	156.450	19	156.950	161.550	37A ^{*3}	157.850	157.850	69	156.475	156.475	79	156.975	161.575	P4 ^{*3}	161.425	161.425
10	156.500	156.500	20	157.000	161.600	60	156.025	160.625	70 ^{*1}	156.525	156.525	80	157.025	161.625			

*1 DSC operation only.

*2 Channels 15 and 17 may also be used for on-board communications provided the effective radiated power does not exceed 1 W, and subject to the national regulations of the administration concerned when these channels are used in its territorial waters.

*3 UK Marina Channels: M1=37A (157.850 MHz), M2=P4 (161.425 MHz) for U.K. version only

*4 The use of these channels should be restricted to navigation-related communications only and all precautions should be taken to avoid harmful interference to channel 16, e.g. by limiting the output power to 1 W or by means geographical separation.

• **USA channels** (for U.K. version only)

CH	Frequency (MHz)		CH	Frequency (MHz)		CH	Frequency (MHz)		CH	Frequency (MHz)		CH	Frequency (MHz)		CH	Frequency (MHz)	
	Transmit	Receive		Transmit	Receive		Transmit	Receive		Transmit	Receive		Transmit	Receive		Transmit	Receive
01A	156.050	156.050	12	156.600	156.600	22A	157.100	157.100	64A	156.225	156.225	75*1	156.775	156.775	85	157.275	161.875
--	---	---	13*2	156.650	156.650	23A	157.150	157.150	65A	156.275	156.275	76*1	156.825	156.825	85A	157.275	157.275
03A	156.150	156.150	14	156.700	156.700	24	157.200	161.800	66A	156.325	156.325	77*1	156.875	156.875	86	157.325	161.925
--	---	---	15*2	156.750	156.750	25	157.250	161.850	67*2	156.375	156.375	78A	156.925	156.925	86A	157.325	157.325
05A	156.250	156.250	16	156.800	156.800	26	157.300	161.900	68	156.425	156.425	79A	156.975	156.975	87	157.375	161.975
06	156.300	156.300	17*1	156.850	156.850	27	157.350	161.950	69	156.475	156.475	80A	157.025	157.025	87A	157.375	157.375
07A	156.350	156.350	18A	156.900	156.900	28	157.400	162.000	70*3	156.525	156.525	81A	157.075	157.075	88	157.425	162.025
08	156.400	156.400	19A	156.950	156.950	37A*4	157.850	157.850	71	156.575	156.575	82A	157.125	157.125	88A	157.425	157.425
09	156.450	156.450	20	157.000	161.600	61A	156.075	156.075	72	156.625	156.625	83A	157.175	157.175	P4*4	161.425	161.425
10	156.500	156.500	20A	157.000	157.000	--	---	---	73	156.675	156.675	84	157.225	161.825			
11	156.550	156.550	21A	157.050	157.050	63A	156.175	156.175	74	156.725	156.725	84A	157.225	157.225			

*1 Low power only.

*2 Momentary high power.

*3 DSC operation only.

*4 UK Marina Channels: M1=37A (157.850 MHz), M2=P4 (161.425 MHz) for U.K. version only

NOTE: Simplex channels, 3, 21, 23, 61, 64, 81, 82 and 83 **CANNOT** be lawfully used by the general public in U.S.A. waters.

Count on us!

< Intended Country of Use >

- GER FRA ESP SWE
 AUT NED POR DEN
 GBR BEL ITA FIN
 IRL LUX GRE SUI
 NOR