

INSTALLATION MANUAL

Simrad GI51
Gyro Interface



www.simrad.com

ALWAYS AT THE FOREFRONT OF TECHNOLOGY
Busse-Yachtshop.de info@busse-yachtshop.de

SIMRAD
A KONGSBERG Company

Note!

Simrad AS makes every effort to ensure that the information contained within this document is correct. However, our equipment is continuously being improved and updated, so we cannot assume liability for any errors which may occur.

Warning!

The equipment to which this manual applies must only be used for the purpose for which it was designed. Improper use or maintenance may cause damage to the equipment or injury to personnel. The user must be familiar with the contents of the appropriate manuals before attempting to operate or work on the equipment.

Simrad AS disclaims any responsibility for damage or injury caused by improper installation, use or maintenance of the equipment.

Copyright

© 2004 Simrad AS

The information contained within this document remains the sole property of Simrad AS.

No part of this document may be copied or reproduced in any form or by any means, and the information contained within is not to be communicated to a third party, without the prior written consent of Simrad AS.

Installation Manual GI51 Gyro Interface

This manual is to be used when installing the Simrad GI51 Gyro Interface.

Document revisions

Rev	Date	Written by	Checked by	Approved by
A	18.02.04	<i>JOS</i>	<i>V.P./G.K./T.J./T.R.</i>	<i>T.R.</i>
B	30.04.04	<i>JOS</i>	<i>V.P./G.K./T.J.</i>	<i>T.J.</i>

Document history

Rev. A	First issue
Rev. B	Updated to include new functions. Corrections/updates added to other pages .

To assist us in making improvements to this manual, we would welcome comments and constructive criticism. Please send all such - in writing to:

Simrad Egersund AS
Nyåskaien
P.O. Box 55
N-4379 Egersund, Norway

or by e-mail to:
simrad.documentation@simrad.com

Contents

1	INTRODUCTION	5
2	INSTALLATION.....	5
2.1	Mechanical installation	5
2.2	Cabling	5
	GI51 Block diagram	6
2.3	Dip switch settings.....	7
2.4	Interface setup procedure.....	8
2.5	Offset adjustment.....	8
2.6	Calibration.....	9
2.7	Initial heading and heading change test.....	10
2.8	S9 Steering lever.....	11
3	GI51 PCB	12
3.1	Component location	12
3.2	Terminal description	13
	TB1, Power.....	13
	TB2, Sin/Cos Out	13
	TB3, Synchro In.....	13
	TB4, NFU	13
	TB5, Step Out.....	13
	TB6, Step In.....	14
	TB7 and TB8, NMEA.....	14
	TB9, RGC proprietary	14
	TB10, LOG	14
	TB11, Radar	14
	TB12, Selector	15
4	PENDULUM FUNCTION KEY (OPTION).....	16
5	TROUBLE SHOOTING.....	17
5.1	LED indicators.....	18
6	SPARE PARTS.....	19
7	TECHNICAL SPECIFICATIONS	20
7.1	Hardware	20
7.2	Supply	20

7.3	Interface	21
	Input.....	21
	Output.....	21
	Other serial output/input.....	22

1 INTRODUCTION

The GI51 is a multi purpose interface unit designed for converting various input signals to Robnet, sin/cos, stepper signal, NMEA 0183, and Clock Data output signals. Refer **TECHNICAL SPECIFICATIONS**, page 20.

The GI51 may be used both in a Robnet system and as a stand-alone unit.

Note!

If GI51 is used together with the AP20 or AP35/16, it must be configured as stand alone.

The unit has a pendulum ferry feature that will change the heading output by 180° on command when the unit is connected to Robnet. If not connected to Robnet, an optional GI51 function key is required to activate the pendulum ferry function. Refer **PENDULUM FUNCTION KEY (Option)**, page 16.

2 INSTALLATION

2.1 Mechanical installation

The GI51 should be mounted with regard to the environmental protection and temperature range of the unit, and should not be installed in area exposed for heavy vibrations.

Make allowances for working area around the unit when routing or removing the cables.

Fasten the GI51 to the bulkhead. Refer mechanical drawing, page 20.

2.2 Cabling

All cable conductors are terminated in screw terminals on the GI51 pcb.

Connect equipment according to the block diagram on page 6, and to **Terminal description**, page 13 onwards.

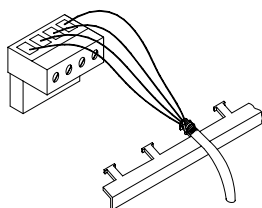

To make a good ground connection, strip about 1 cm (0.4”) off the cable’s insulation and pull the screen backwards to cover the insulation. Position the straps as shown in the figure. Tighten well to make sure the screen makes good contact.

This will also avoid vibration causing the cables to loose connection.

Note!

Be careful not to drop screen cuts over the components!

GI51 Block diagram

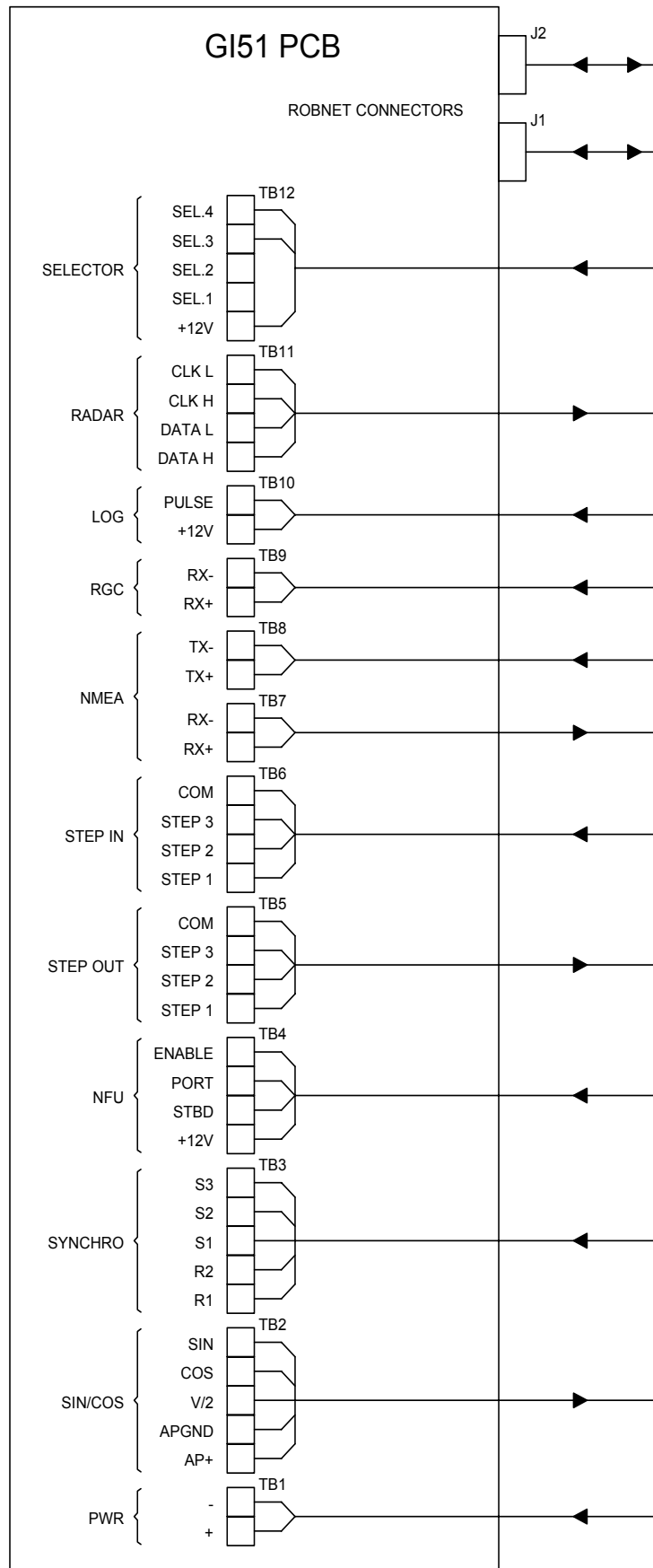

2.3 Dip switch settings

The following dip-switches have to be set correctly:

- SW1-1 and SW1-2 determine the gearing ratio for synchro input. For 1:1 synchro or if synchro is not used, both are set to OFF
- SW1-3 determines the format of the clk/data heading signal to the radar. If the unit is powered by the Robnet, the format is set from the autopilot control unit. Hence the switch is not used and the settings for the switch is irrelevant.
- SW1-4 can be used for test and trouble shooting (ref. page 17). When the switch is set to ON, the heading at all outputs will jump in circles in a sequence of 45° each 10 sec.
- SW2-1 set to OFF gives NMEA and Robnet speed output from the pulse log input. If set to ON, speed will be taken from the longitudinal water speed field of VBW (1.priority) or VHW (2.priority) of the NMEA input.
- SW2-2 is used to determine the internal gain for high voltage 50-100V ref. (L/L or low voltage, 26V ref., 11.8V L/L synchros. OFF sets the gain for high voltage level (others), ON sets the gain for low voltage, 26V/11.8 V L/L.

All switches are factory set to OFF.

For location of the dip-switches, refer to **Component location**, page 12.

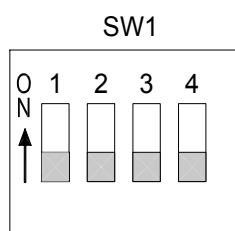

Switch no.	Position/Function	
	OFF	ON
SW1-1	Synchro 1:1	Synchro 90:1
SW1-2	Synchro 1:1	Synchro 360:1
SW1-3	Simrad clk/data (Stand-alone)	Furuno clk/data (Stand-alone)
SW1-4	Normal	Heading test

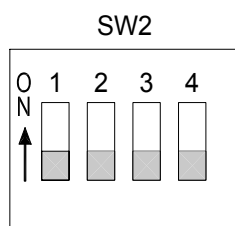

Switch no.	Position/Function	
	OFF	ON
SW2-1	NMEA log	Pulse log
SW2-2	Others	26V Ref., 11.8V L/L
SW2-3	NC	NC
SW2-4	NC	NC

2.4 Interface setup procedure

When a compass is connected to the GI51 via Robnet, it is required to configure the compass in the autopilot Interface Setup Menu.

Note!

For AP50 the gyro type has to be selected under the “GI-menu” shown in the Interface menu.

The procedure to access the Interface Setup Menu is detailed in the respective autopilot manual.

If more than one compass is connected to a GI51, operating as “stand alone”, the input compass will be selected at power on in the following order: Synchro (1.priority) → Step → RGC → NMEA.

2.5 Offset adjustment

Without Robnet connection to GI51, heading offset adjustment is required after power on. This can be done either by a proprietary NMEA data (ref. page 22) or by an external switch connected between the SEL 3 and +12V.

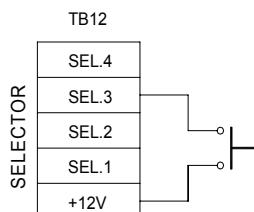

The switch must be a potential free pulse type. When pressing and holding the switch, the heading will increase or decrease, depending of last direction control.

The heading will increase in a slow rate for the first 2 degrees, but change to high rate for as long as the switch is depressed. By making a quick double press and keep the last press, the direction is reversed and started with low rate. Single presses on the switch changes the heading by one tenth of a degree.

The switch should be mounted in a location for convenient operation.

Note!

Make sure that the switch is mounted on a protected area to avoid unintended operation that will give large heading changes!

2.6 Calibration

For other types of synchro voltages, it is recommended to perform a heading calibration to obtain the maximum heading accuracy. Calibration can be performed by either turning the vessel, slew the compass or rotating the synchro. As the internal gain is related to synchro voltage, dip switch SW2-2 is used to select “high reference voltage” (50-100V) or “low reference voltage” (26V). See page 7. Note that no calibration is required for geared synchros. The calibration may be omitted if reduced accuracy (1-2°) can be accepted.

When connected to a Simrad autopilot, the calibration is started from the autopilot (Robnet). It will be confirmed and read in the autopilot (confirmed or failed). The GI51 is factory calibrated for Simrad RGC50/10/11 type gyro with 1:1 synchro. Note that RGC11 and 1:1 synchro is NOT standard but optional. See autopilot manual for more info.

When compasses are connected to GI51 as “stand alone” and calibration may become difficult or impractical due to vessel size, port condition etc, a separate dip switch (SW2-2) function is included to avoid the calibration. See Dip switch settings, page 7.

Note!

For a 1:1 synchro, minor errors may be present, therefore a calibration when the vessel is out at the open sea is recommended. Use the following procedure:

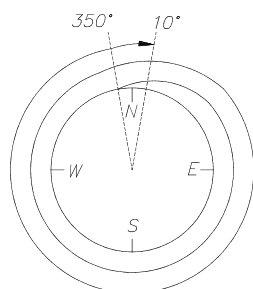

- 1 Connect the power to the GI51.
- 2 Make some 360 degrees turns within 10 minutes from power-on. Normally the compass becomes calibrated within passing north three times. The heading sensor should now be calibrated. The green CPU Running LED changes from flashing to constant on for about 7 seconds, indicating that the calibration is accepted.

Note!

If you have access to a computer with the appropriate NMEA interface, you can perform a calibration procedure using the proprietary sentences as listed in page 22.

2.7 Initial heading and heading change test

This section describes how to verify that the heading read-out from the GI51 is following the correct direction of change along with the gyro. In some cases, it may be encountered that the autopilot heading read-out is different from the gyro heading. Two possibilities of error may exist:

- 1 Compass read-out on the autopilot is different from the gyro card read-out, but the heading difference is a constant on all headings. This condition can be corrected by simply dialing in the correct heading value from the Seatrial Menu item called Compass Offset, presented directly after the Compass Calibration menu item, from the Seatrial Settings Menu.
- 2 If there is a difference of approximately 120° or 240° between the master compass heading and the autopilot/repeaters when the NMEA signal is used, S1 - S2 - S3 and R1 - R2 connections between the master compass and GI51 need to be changed. Use one of the alternatives listed below.

If the compass can be slewed (heading changed) use the procedure in Alternative 1. If it is not possible to slew the compass, Alternative 2 should be used:

Alternative 1

- Disconnect S1 - S2 - S3 from GI51 TB3.
- Slew the master compass to 000°.
- Use a multimeter and measure the AC voltage (0 - 90V range) between S1 - S2 - S3 on the disconnected wires.
- Locate the two phases where the voltage is approx. 0 volt. These are the S1 and S3 lines. Connect S1 - S3 - S2 accordingly.
- If the change in heading is in the same direction for the master compass and the repeaters, but a constant 180° offset is present, the R1 and R2 lines need to be interchanged. (This does not reverse the rotation).
- Rotate the master compass to make the heading increase. If the repeater heading decreases, the S1 and S3 lines need to be interchanged.

Alternative 2

- The sequence of connections S1-S2-S3, R1 and R2 may be wrong. Reversing two phases will change the direction. Swapping S1 to S2, S2 to S3 and S3 to S1 will change the response by 120° or 240°. Interchanging R1-R2 will change the heading by 180°.

If only a constant small error should occur, loosen the fixing screws for the synchro transmitter and adjust by moving the synchro transmitter for correct heading output from the GI51.

2.8 S9 Steering lever

The S9 Steering Lever can be added to an autopilot system to provide remote non-follow up steering capability. The S9 is designed to be mounted in weather exposed locations. If it is installed in such location, it is recommended to insure that the cable entry glands are properly tightened. In addition silicone sealant should be added around cable to ensure water protection.

As the mode selection by the Enable signal is based on a pulse, it is recommended that only one S9 lever is used. This because the mode selection switch is fixed levels, not pulsed. If several NFU levers are required, the S35 lever is recommended.

3 GI51 PCB

3.1 Component location

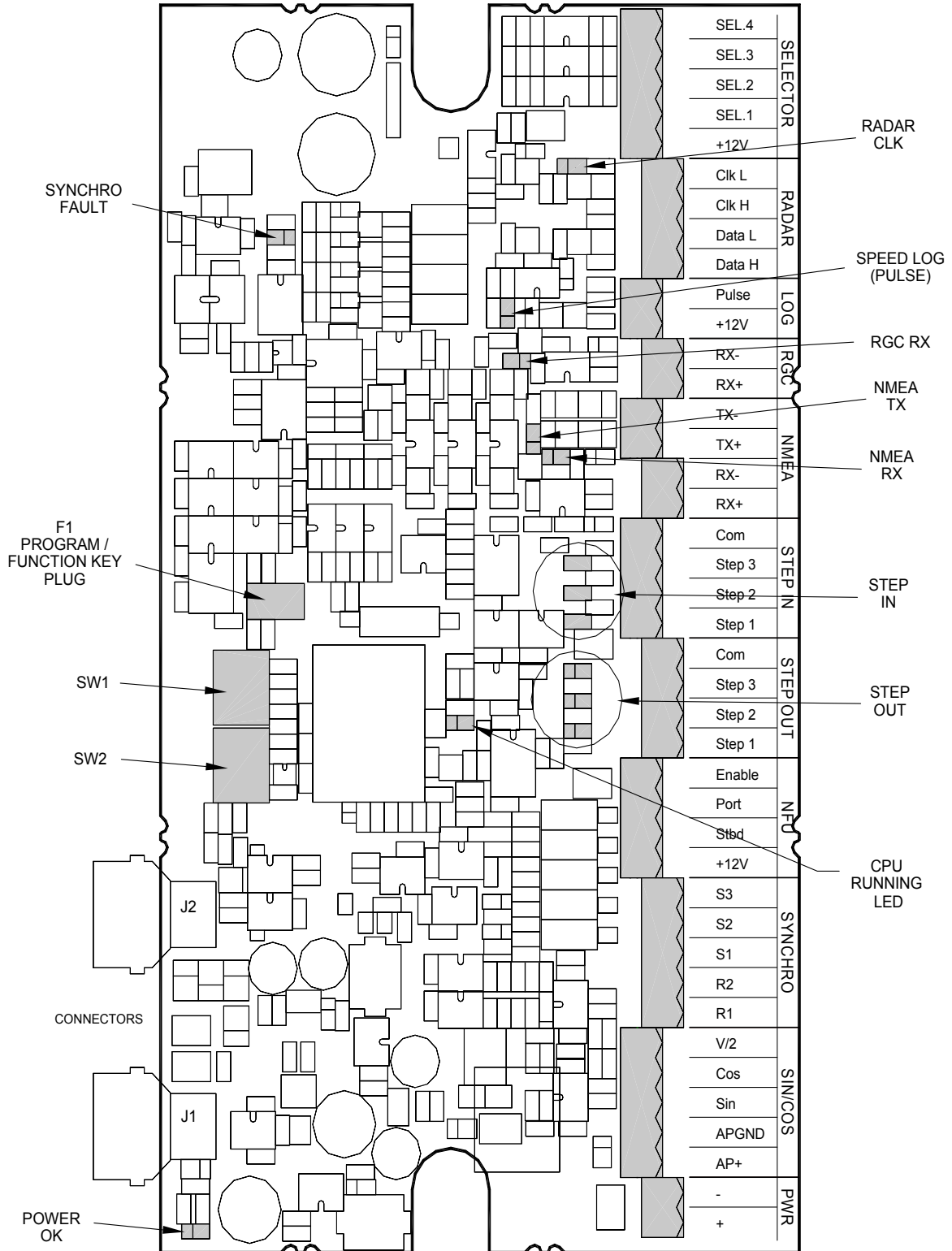

3.2 Terminal description

TB1, Power

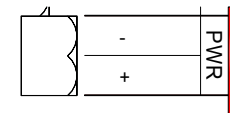

Used for power connection when GI51 is not powered by Robnet.

When power is connected to TB1 in a Robnet system, GI51 will continue to output gyro heading even if the autopilot is turned OFF.

TB2, Sin/Cos Out

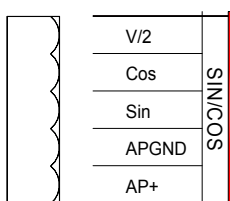

Used for heading output to certain models of Simrad autopilots (AP200 series, AP45, AP9).

TB3, Synchro In

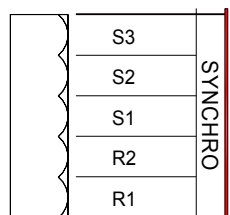

Used for connecting gyro compasses with synchro output. Refer *Dip switch settings*, page 7 for signal specification.

TB4, NFU

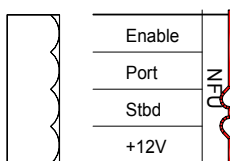

Used for connecting a remote Non Follow Up lever. Rudder command or course change will be sent to the autopilot via Robnet.

Simrad S9 lever also enables remote auto/NFU mode switching.

TB5, Step Out

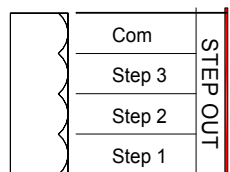

Used for operating heading repeaters with step input.

Note!

Step signals only for electronic interface, not for step motors!
See *TECHNICAL SPECIFICATIONS*, page 20.

TB6, Step In

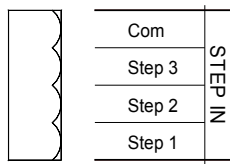

Used when connecting a gyro compass with stepper output.

TB7 and TB8, NMEA

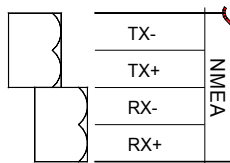

NMEA signals from compass or speed log with serial output should be connected to RX- and RX+. Refer Dip switch settings for speed, page 7.

Output heading from active steering compass and speed from log in the GI51 is available on TX- and TX+.

TB9, RGC proprietary



Used for reading serial data (9600 baud) from gyro compass (RGC11, RGC12).

TB10, LOG

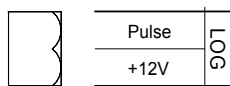

Used for connecting speed log with 200p/NM. Refer *Dip switch settings*, page 7.

TB11, Radar

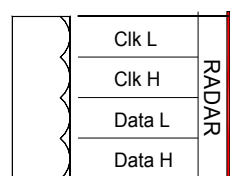

Data and Clock output signal to Radar.

Simrad or Furuno format is selected via Robnet, or set by dip switch SW1 if GI51 not is connected to Robnet. Refer *Dip switch settings*, page 7.

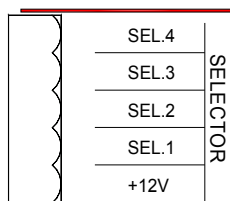

TB12, Selector

The selector lines option on TB12 are used both for heading offset adjustment and for the optional pendulum function key as described below.

Offset heading adjustment

Offset of initial heading will be required when a step or geared synchro is connected in a stand-alone system. The function is obtained by connecting a pulse switch between TB12, +12V and SEL 3. When pressing and holding the switch, the heading will increase or decrease, depending of last direction control.

The heading will increase in a slow rate for the first 3 degrees, but change to high rate for as long as the switch is depressed. By making a quick double press and keep the last press, the direction is reversed and started with low rate. Single presses on the switch changes the heading by one tenth of a degree.

Pendulum ferry feature

Based on reading an external potential free switch connected to this terminal, GI51 will change the heading output 180° on command for both the steering compass and monitor compass (if installed).

The switch is connected between +12V and SEL.4.

4 PENDULUM FUNCTION KEY (Option)

If GI51 not is connected to Robnet, an optional Pendulum function key (part no. 20213815) has to be installed to activate the pendulum function. When this key is installed, GI51 will change the heading output by 180° based on signal from a potential free closing contact between TB12, Sel 4 and +12V on the GI51 pcb. Refer page 15.

A LED is visible through the whole on the key. The LED has the following indication:

- No light: true heading output
- Intermediate flashing: heading is changed 180°

Use the following procedure to install the pendulum key:

1. Remove power from the GI51 unit.
2. Open the unit and locate P1 on the pcb. Refer Component location, page 12.

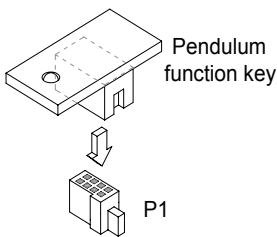

3. Carefully insert the pendulum function key into P1. Observe the guiding slot as indicated on the figure.
4. Press carefully until the key is properly inserted.

5 TROUBLE SHOOTING

For location of the LEDs, refer to *Component location*, page 12.

SYMPTOM	CORRECTIVE ACTION
The unit is inoperative.	<ol style="list-style-type: none"> 1. Check that the POWER OK LED is lit. 2. Check that the CPU RUNNING LED is alternating at 1Hz.
No compass output.	<ol style="list-style-type: none"> 1. Check LED indicator(s) for all heading outputs. Note that whenever the selected input compass is unreliable (signal missing, invalid flag received etc), GI51 will: <ul style="list-style-type: none"> - Turn on all 3 LEDs for step out - Set sin/cos to zero - Stop clk/data output - Transmit invalid flag and empty heading field in NMEA output 2. If all output indicators operate ok, check cabling for missing output signal. 3. If output indicators show missing or invalid input (all 3 LEDs for step out is lit etc), check LED(s) for selected input compass. 4. If LED(s) for selected input compass operate ok, check compass status. 5. If LED(s) for selected input compass indicate missing signal, check input cabling. 6. For synchro input, check the Synchro Fault LED which will be lit if the reference or any of the phases are missing. Also check correct setting of DIP switches (no output if both SW1-1 and SW1-2 are ON).

SYMPTOM	CORRECTIVE ACTION
No speed output	<ol style="list-style-type: none"> 1. Check LED indicator for Speed Log input or NMEA RX (depending upon which signal that is selected by DIP switch SW2.1). 2. Check LED for NMEA input. 3. If input signal is missing, check cabling or status of speed log. 4. If input signal is ok, check cabling for output signal

Note! *If pulses from the speed log fail to appear, the speed will decrease towards zero during the next half minute before the speed output is stopped.*

5.1 LED indicators

Several LED indicators are used to indicate correct status for power and input/output signals.

For location of the LEDs, refer to *Component location*, page 12.

LED NO.	COLOUR	INDICATION
D1	Green	CPU running indicator. Flashes with apr. 1Hz when the processor is running.
D103	Green	Power polarity indication. Green light when polarity is correct.
D400	Green	Step out indicators. Flashes with Step Out signal.
D401		
D401		
D603	Green	NMEA In indicator. Flashes with NMEA In signal.
D602	Green	NMEA Out indicator. Flashes with NMEA Out signal.
D1000	Green	Step In indicators. Flashes with Step In signal.
D1001		
D1002		
D1301	Green	RGC proprietary indicator. Flashes with RGC proprietary signal.
D1600	Red	Synchro fault indicator. Will be lit if any signal is lost or if no synchro is connected.

6 SPARE PARTS

PART NO.	DESCRIPTION
20213773	GI51 Gyro Interface
20213278	GI51 board
20213815	GI51 Pendulum key

7 TECHNICAL SPECIFICATIONS

7.1 Hardware

Dimensions:See figure below
 Weight: 0.8 kg (1.8 lbs.)
 Material:.....Epoxy coated aluminum
 Environmental Protection: IP44
 Safe distance to magnetic compass: 0.2 m (0.7 ft.)
 Temperature range:
 Operation:..... -25 to +55 °C (-13 to +130 °F)
 Storage:..... -30 to +80 °C (-22 to +176 °F)
 Cable inletsRubber glands for cable diameter 10-14mm
 Mounting: Bulkhead mount

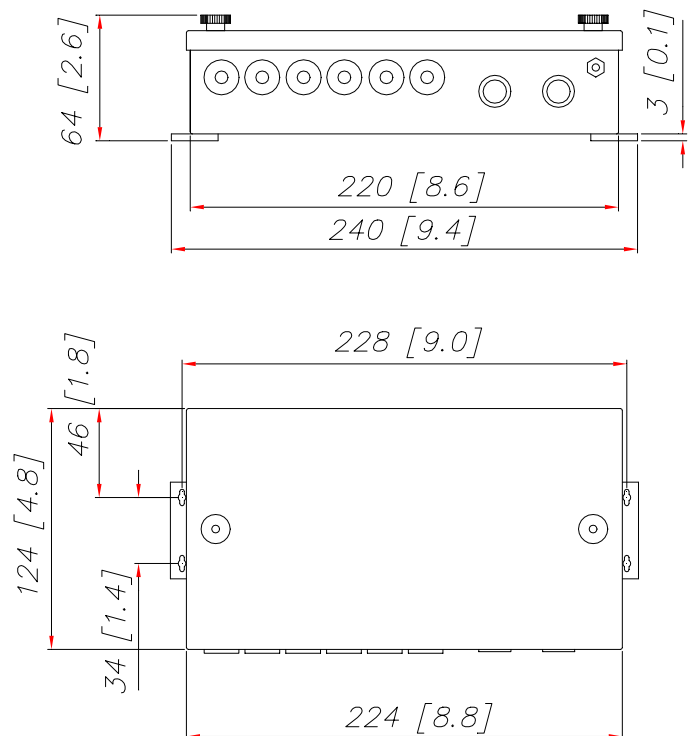

7.2 Supply

Supply voltage: 12, 24 or 32V DC +30%/-10% or Robnet (26-42V DC)
 Power consumption:2.4 W
 Load: Maximum 20 mA

7.3 Interface

Input

Synchro 1:1, 90:1, 360:1	26 - 115V, 400Hz ext exit, +/-0.5° accuracy
Synchro 90:1, 360:1	50 - 60V, 50 - 60Hz ext exit, +/-0.5° accuracy
Step, 6 step/°, max rate 40°/sec:	20-70V, common high or common low, low <= 7V
NMEA183 heading and speed ..HDT, HDG, HDM, VBW, VHW	
RGC11 serial heading	9600 baud
RGC12 serial heading	9600 baud
Speed log 200 p/NM	Pot. free contact, 20mA
NFU with mode sel. (S9)	Pot. free contacts
Robnet	Heading (steering comp., T or M), Radar interf. type
Selector	Pendulum function Offset adjustment

Output

Analog sin/cos (AP45)	0-5V DC
Step 6 step/°, max rate 20°/sec:	24V DC, 20mA
Simrad (Anritsu)/Furuno clk /data for 2 radars	0-5V, 40Hz, 20mA
NMEA183	
Heading	HEHDT/HEHDG, 10Hz
Speed and heading:	HEVHW (PSIMVHW if unaligned geared synchro or step), 1Hz
Rate of turn:	TIROT if rate input according to IMO A.526 (13)
.....	AGROT (autopilot system) or IIROT (stand alone) if calculated from heading
Robnet (AP35, AP50)	Heading T & M, speed, NFU

EUROPE

AUSTRIA

Allroundmarin-Alltechnik
GesmbH
Rheinboldtstrasse 11-13
A-2362 Biedermannsdorf
b.Wien
Tel.: +43 2236 646 760
Fax: +43 2236 63135
www.allroundmarin.com

BENELUX

Simrad BV
P. O. Box 587
3200 AM Spijkensisse
Tel.: +31 181 600234
Fax: +31 181 626688
www.bennexholland.nl

CROATIA

Almar d.o.o.
Porec - Kamenarija 12
52452 Funtana
Tel.: +385 52 445 005
Fax: +385 52 445 276

CYPRUS

Regis Marine Electr. Ltd.
163 Leontiou A Street
PO Box 56320
CY-3360 Limassol
Tel.: +357 25 366977
Fax: +357 25 347209

DENMARK

Simrad AS (DK)
Naverland 22
DK-2600 Glostrup
Tel.: +45 43 44 49 00
Fax: +45 43 44 48 99
www.simrad.dk

ESTONIA

Balti Merekaatrid
Marine Department
Pärnu Mnt. 232
11314 Tallinn
Tel.: +372 67 10 002
Fax: +372 67 10 076

FINLAND

(Professional)
AT - Marine OY
Mesikukantie 16
FIN 01300 Vantaa
Tel.: +358 9 5494 2600
Fax: +358 9 5494 2700
www.atmarine.fi

(Recreational)

Oy Maritim Ab
Veneentekijäntie 1
SF 00210 Helsinki
Tel.: +358 9 681 631
Fax: +358 9 692 7917
www.maritim.fi

FRANCE

Simrad S.A.
Parc d'Activités Ragon
23 Avenue Pasteur
44 119 Treillieres
Tel.: +33 2 28 01 23 01
Fax: +33 2 28 01 21 43
www.simrad.fr

GERMANY

Simrad GmbH & Co. KG
Dithmarscher Strasse 13
26723 Emden
Tel.: +49 4921 96860
Fax: +49 4921 968677
www.simrad.de

GREAT BRITAIN

Simrad
Unit 810, Fareham Reach
166 Fareham Road, Gosport
Hampshire PO13 0FW
Tel.: +44 1329 245100
Fax: +44 1329 245111
www.simrad.com

GREECE

Aegean Electronics S.A.
1-3, Akti Miaouli Str.
EL-185 35 Piraeus
Tel.: +302 10 413 7269
Fax: +302 10 413 7270

ICELAND

Fridrik A. Jonsson ehf
Eyjarslod 7
P.O.Box 362
121 Reykjavik
Tel.: +354 552 2111
Fax: +354 552 2115

ITALY

Simrad Srl.
Viale Odone Belluzzi 57
00128 Rome
Tel.: +39 06 5078 1022
Fax: +39 06 5078 1024
www.simrad.it

MALTA

Medcomms Ltd.
4 Msida Rd.
Gzira GZR03
Tel.: +356 21 335521
Fax: +356 21 310820

NORWAY

Simrad Marine AS
Joh. Berentsensvei 109
P.O. Box 53, Laksevåg
N-5847 Bergen
Tel.: +47 55 94 10 00
Fax: +47 55 94 10 05
www.simrad.no

POLAND

Escort Ltd. Electronics Syst.
Ul. Energetyków 9
70-656 Szczecin
Tel.: +48 91 462 4379
Fax: +48 91 462 4408
www.escort.com.pl

PORTUGAL

Nautel - Sistemas Maritima
Lda.
Edificio Liscont, 1'
Cais de Alcantara
1399-037 Lisboa
Tel.: +351 21 392 0940
Fax: +351 21 392 0949
www.nautel.pt

RUSSIA

Moretron Service Ltd.
SIVA Center
Podgornaya Str. Rybny Port
183001 Murmansk
Tel.: +7 8152 459781
Fax: +7 8152 459791
www.moretron.ru

Simbia Engineering
Company, Ltd.
4A Verhneozernaja Str.
236018 Kaliningrad
Tel.: +7 0112 215492
Fax: +7 0112 365380

Norwegian Partners
Marine AS
5-A Svetlanskaya Str.
690091 Vladivostok
Tel.: +7 4232 414627
Fax.: +7 4232 300457
www.npm.no

SPAIN

Simrad Spain, S.L.
Partida Torres N° 38
Nave 8 Y 9
03570 Villajoyosa
(Alicante)
Tel.: +34 96 681 01 49
Fax: +34 96 685 23 04
www.simrad.sl

SWEDEN

Simrad AB
Svalörtsgatan 14
42668 Västra Frölunda
Tel.: +46 31 69 51 00
Fax: +46 31 69 51 20
www.simrad.se

SWITZERLAND

Marine Parts Heimgartner
Pfäffikerstr. 6
CH 8604 Volketswil/Zürich
Tel.: +41 1 997 40 90
Fax: +41 1 997 40 94

TURKEY

Promar Marine Equip. Ltd.
Igrip Sokak Gul Apt. No:
7/2
81030 Fenerbahce
Istanbul
Tel.: +90 216 3460894
Fax: +90 216 3461493
www.promar.com.tr

AFRICA

MOROCCO

Soremar
17 Rue le Catelet
BD Emile Zola
21900 Casablanca
Tel.: +212 22 40 50 50
Fax: +212 22 24 82 36

NORTH WEST AFRICA

Simrad NW Africa
1, Place Al Istiqlal
Angle Ave. Des FAR
20000 Casablanca
Morocco
Tel.: +212 22 54 1816/1535
Fax: +212 22 54 15 37

SOUTH AFRICA

Marine Radio Acoustic
Devices
P. O. Box 12076
N1 City 7463
Cape Town
Tel.: +27 21 559 4003
Fax: +27 21 559 2752

MIDDLE EAST

ISRAEL

YAMIT Y.S.B LTD.
P. O. Box 6158
61061 Tel-Aviv
Tel.: +972 3 5271 778
Fax: +972 3 5271 772

UNITED ARAB EMIRATES

Emphor FXCO
P. O. Box 6488
Dubai
Tel.: +971 4 324 7500
Fax: +971 4 324 7503

LEBANON

Selcom Marine Sarl
P. O. Box 55541
Dekwaneh Main Street
Beirut
Tel.: +961 149 1489
Fax: +961 149 5325

IRAN

Darya Negar Co.
Office 2, 1st Floor,
Bldg. No. 64
Fatemi Square
Teheran
Tel.: +98 21 896 7872
Fax: +98 21 896 6658

PACIFIC

AUSTRALIA

Quin Marine Pty. Ltd.
89 St Vincent Street
Port Adelaide, SA 5015
Tel.: +61 88 447 1277
Fax: +61 88 341 0567

NEW ZEALAND

Advance Trident Ltd.
P.O. Box 4174
Kingsland
Auckland
Tel.: +64 9 845 5347
Fax: +64 9 845 5348
www.advancetrident.com

ASIA

SINGAPORE

Jason Electronics Pte Ltd.
Blk 194 Pandan Loop #06-05
Pantech Industrial Complex
Singapore 128383
Tel.: +65 6 872 0211
Fax: +65 6 872 1800

CHINA & HONG KONG

CITE Limited
Rm C-E, 16/F, Yan's
Tower,
26-27 Wong Chuk Hang
Road, Aberdeen
Tel.: +852 2 552 0178
Fax: +852 2 873 0679

INDIA

Norinco Pvt Ltd.
Karshaka Road
Cochin 682016
Tel.: +91 484 2323 675
Fax: +91 484 2323 694

INDONESIA

PT Sarana Teknologi
Samudera
Wisma Dharmala Sakti
Annexe Building 7th Floor
JL. Jenderal Sudirman
Kav.32
Jakarta 10220
Tel.: +62 21 570 61 28
Fax: +62 21 570 72 21

SOUTH KOREA

Lucky Susan Co. Ltd.
K.P.O. Box 1666, Seoul
Taesung B/D. #508
60-17, Taepyong-Ro 1-Ka
Chung-Ku, Seoul
Tel.: +82 2 736 4328
Fax: +82 2 739 5689

Turn-On Electronics Co.
7th fl., Dong-A Ilbo Bldg.
53-11, 4-KA,
Choongang-Dong
Choong-Ku, Pusan
Tel.: +82 51 462 3930
Fax: +82 51 462 3089

JAPAN

Nippon Kaiyo Co, Ltd.
9-2 Sakae-Cho
Kita-Ku
Tokyo 114-0005
Tel.: +81 3 3913 2337
Fax: +81 3 3913 3479

Shipmate Japan Co. Ltd. 2-
5-4 Fukuura
Kanazawa-ku
Yokohama 236-0004
Tel.: +81 45 788 2731
Fax: +81 45 788 2732

TAIWAN

Dragon & Elephant
Enterprise Co. Ltd.
12F-4, No. 251
Min Chuan 1st Road
Kaohsiung, Taiwan ROC
Tel.: +886 722 72887
Fax: +886 722 72910

AMERICAS

CANADA

Simrad Canada Ltd.
P.O. Box 397
112 Lincoln Street
Lunenburg, Nova Scotia
Canada B0J 2C0
Tel.: +1 902 640 3300
Fax: +1 902 640 3070
www.simrad.com

USA

Simrad Inc.
19210 33rd Avenue West
Suite A
Lynnwood WA 98036
Tel.: +1 425 778 8821
Fax: +1 425 771 7211
www.simrad.com

Simrad Inc.

1500 NW 1st Street
Suite 1-E
Dania, FL 33004
Tel.: +1 954 922 7700
Fax: +1 954 922 0707
www.simrad.com

ARGENTINA

R.C. International
Av. Corrientes 2958 11th 38
1193 Buenos Aires
Tel.: +54 11 4862
5774/4865 7621
Fax: +54 11 4862 5774

BRAZIL

Demo Offshore Ltda
Av. Marechal Camara 160
Sala 614,
Centro Rio de Janeiro
RJ-20020-080
Tel.: +55 21 2524 5171
Fax: +55 21 2532 0254

CHILE

Simrad S.A.
Casilla 19012, Correo 19
Vitacura
Santiago
Tel.: +56 2 207 3059
Fax: +56 2 207 2695

PERU

Simrad Peru S.A.
Calle Los Topacios 266-268
Urb. San Antonio
Bellavista – Callao
Tel.: +51 1 453 7477
Fax: +51 1 453 7325

URUGUAY

Electromaritima Uruguaya
Ltda.
Guatemala 1260
11800 Montevideo
Tel.: +59 8 2 924 7139
Fax: +59 8 2 924 7138

The above companies represent only main importers. Each country is in addition served by a network of local service outlets.

Some importers represent only specific market segments according to the following codes:
Professional:
Coastal and Fishery market
Recreational:
Leisure market

SIMRAD
A KONGSBERG Company

www.simrad.com