

ALWAYS AT THE FOREFRONT OF TECHNOLOGY

SIMRAD
A KONGSBERG Company

M A N U A L

Simrad IS12
Data Instrument

© 2001 Simrad Ltd

The technical data, information and illustrations contained in this publication were to the best of our knowledge correct at the time of going to print. We reserve the right to change specifications, equipment, installation and maintenance instructions without notice as part of our policy of continuous development and improvement.
No part of this publication may be reproduced, stored in a retrieval system or transmitted in any form, electronic or otherwise without prior permission from Simrad Ltd.
No liability can be accepted for any inaccuracies or omissions in the publication, although every care has been taken to make it as complete and accurate as possible.

CONTENTS

1	GENERAL	
	1.1 Introduction	6
	1.2 IS12 Network System	7
2	OPERATION	
	2.1 General	8
	2.2 Upper Info Display	9
	2.3 Lower Info Display	9
	2.4 Page Display	10
	2.5 Backlighting	11
	2.6 Remote Control Option	12
3	CALIBRATION	
	3.1 Page Configuration	14
	3.2 Local & Network Backlighting	16
	3.3 Disable Remote Control	17
4	INSTALLATION	
	4.1 Instrument Head Installation	18
	4.1.1 Front Mounting	18
	4.1.2 Rear Mounting	20
	4.2 Electrical Installation	21
	4.3 NMEA Output	22
5	APPENDIX	
	5.1 Fault Finding	23
	5.2 Spares and Accessories	23
	5.3 Dimensions	24
	5.4 Specification	24
	5.5 Service & Warranty	24

1 GENERAL

1.1 Introduction

The Simrad IS12 System is a flexible modular series of instruments that offer large, clear displays, easy to operate functions and robust, weatherproof construction. The IS12 Data is a multiline data repeater that can display information from any master unit in the system.

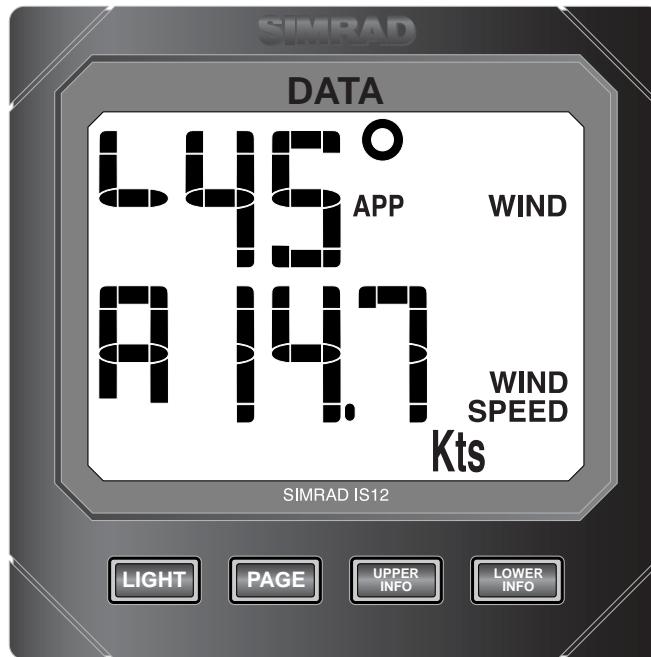

Fig 1.1 - IS12 Data Instrument

The IS12 Data is supplied complete with a 0.3m data cable to enable it to be linked to an existing system. All functions are easily accessed, thanks to IS12's intuitive, user friendly control system.

Thank you for choosing Simrad.

If you are pleased with your instrument we hope you will be interested in our range of marine electronic equipment, which is manufactured to the same high standards as IS12. Please contact your nearest Simrad Agent for a catalogue showing our increasing range of high tech navigational instruments, GPS, autopilots, Radar, Fishfinders and VHF radio sets.

Simrad operate a policy of continual development and reserve the right to alter and improve the specification of their products without notice.

1.2 IS12 Network System

The IS12 system is built around a high speed bus networking system that allows instruments to be easily interconnected and share data.

All units are interconnected and powered using a standard single cable (Fig 1.2) -

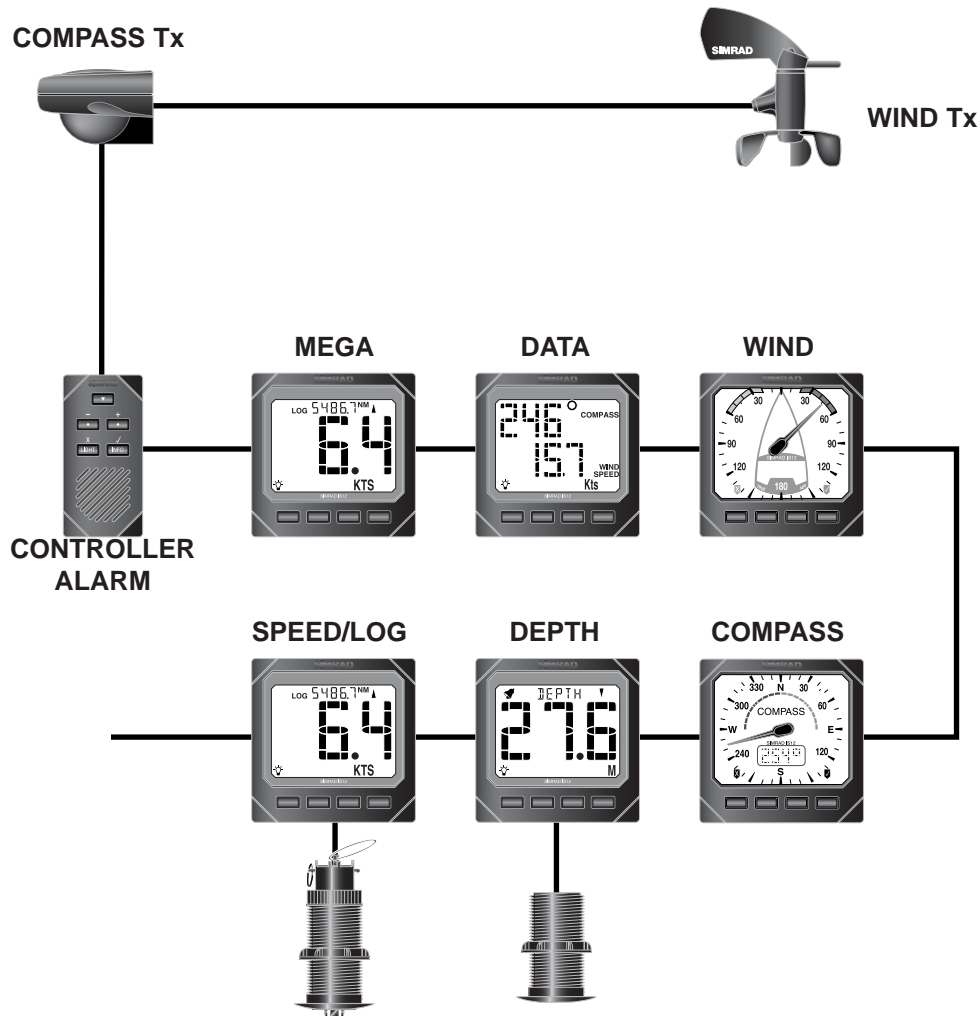

Fig 1.2 - IS12 Network System

Additional instruments can be added to the system to act as repeaters, for example at the chart table of a sailboat or the fly-bridge of a powerboat. Thus, as shown in the example above, the Mega and Data Repeater instruments repeat the information from the main instruments.

2 OPERATION

2.1 General

The IS12 Data is designed to be able to repeat data from any IS12 master unit that is also part of the installation (Fig 2.1) -

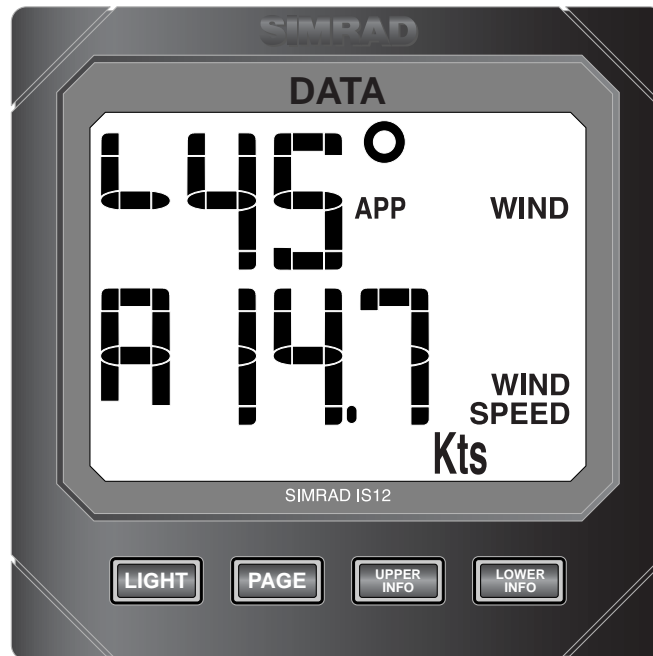

Fig 2.1 - Data Instrument

The example above shows the apparent wind speed and angle, available if an IS12 wind transducer is part of the system.

Data will only be displayed if the relevant master unit is also part of the system (IS12 Speed, Depth, Wind, Compass etc). If the relevant master unit is not available, the display will show “---”.

The top and bottom lines of the display can be individually selected using the **UPPER INFO** and **LOWER INFO** keys, and there are also four preset data Pages available by pressing the **PAGE** key which can be adjusted by the user, allowing commonly used instrument data to be easily displayed.

NOTE

As this unit is a data repeater, no control or calibration functions are available. To adjust any settings (eg depth alarms) or activate any functions (eg race countdown timer), use the relevant master unit.

2.2 Upper Info Display

To choose the data displayed on the top line of the Data, press the **UPPER INFO** key. Repeatedly pressing the **UPPER INFO** key will cycle through the available data -

- Depth ↵
- Shallow Alarm Setting ↵
- Deep Alarm Setting ↵
- Apparent Wind Angle ↵
- True Wind Angle ↵
- Compass Bearing ↵
- Bearing To Waypoint (BTW) ↵
- Course Over Ground (COG) ↵
- Lat/Long ↵

NOTE

The Lat/Long display will fill both the top and bottom lines of the display. In order to display both the Latitude and Longitude, the display will switch between Lat and Long automatically if this is selected (Fig 2.2) -.

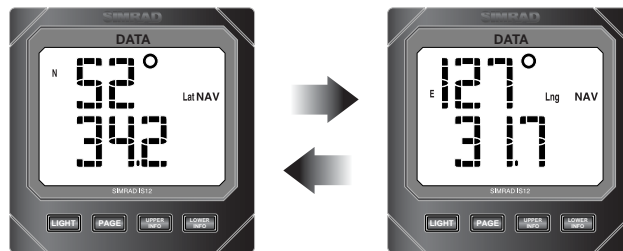

Fig 2.2 - Lat/Long Display

2.3 Lower Info Display

To choose the data displayed on the bottom line of the Data, press the **LOWER INFO** key. Repeatedly pressing the **LOWER INFO** key will cycle through the available data -

- Boat Speed ↵
- Log ↵
- Trip ↵
- Water Temp ↵
- Average Speed ↵
- Max Speed ↵
- Race Countdown / Elapsed Timer ↵
- Apparent Wind Speed ↵
- True Wind Speed ↵
- Wind Speed Alarm Setting ↵
- Rudder Angle ↵
- Speed Over Ground (SOG) ↵
- Cross Track Error (XTE) ↵

2.4 Page Display

The Data instrument includes four programmable display Pages, allowing important or commonly used data to be easily accessible.

To configure the Page layouts, refer to Section 3.1.

To cycle through the four Pages, press the **PAGE** key repeatedly (Fig 2.3) -

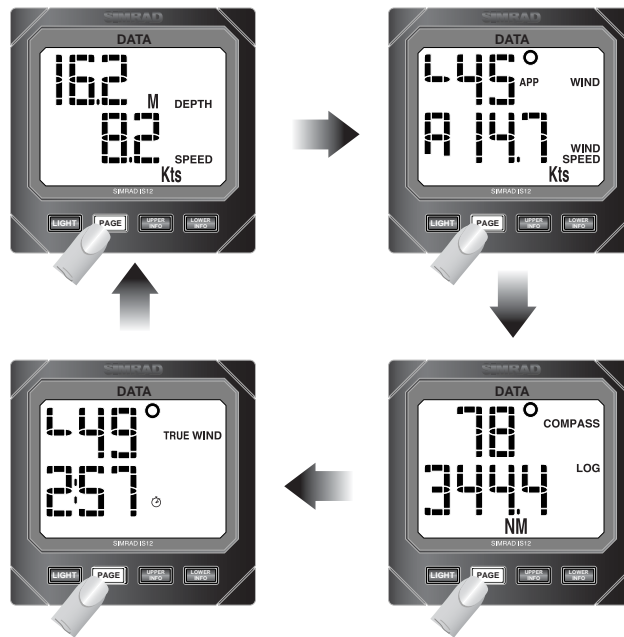

Fig 2.3 - Examples of Page Displays

If the IS12 system is switched off, the previously selected Page will be displayed on power up.

2.5 Backlighting

The backlighting illuminates the display and the keys, with five levels of brightness.

To switch the backlighting on, press the **LIGHT** key. The display will illuminate and the large digits will show the current lighting level (Fig 2.4) -

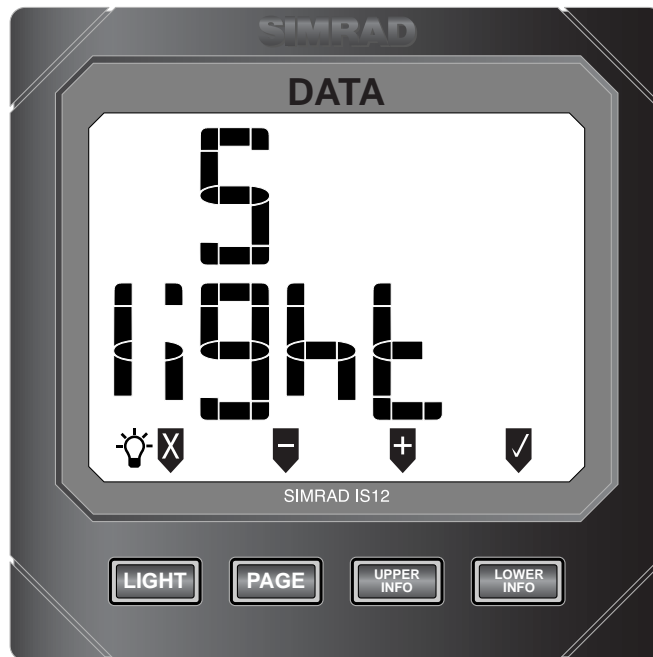



Fig 2.4 - Adjusting Backlighting

Press the **UPPER INFO** key to increase the brightness (max 5), **PAGE** to decrease it (min 1), **LOWER INFO** to accept the selected brightness or **LIGHT** to turn the backlighting off.

NOTE

While the backlighting is on, the lamp icon () will be shown on the bottom left of the display.

The backlighting can either be *Local* or *Network* controlled. Local control means that any adjustments to lighting will only affect this specific instrument. With Network control, all instruments in the network will be affected. See Section 3.2 for more details.

2.6 Remote Control / Alarm Option

The optional remote control allows all functions of each instrument to be remotely controlled. Any alarms sounded are also repeated on this unit. See Section 3.3 regarding enabling and disabling remote control functionality for this instrument.

As this unit is intended to control all instruments in the IS12 range, the keypad is a generic design. Fig 2.5 indicates the respective key positions -

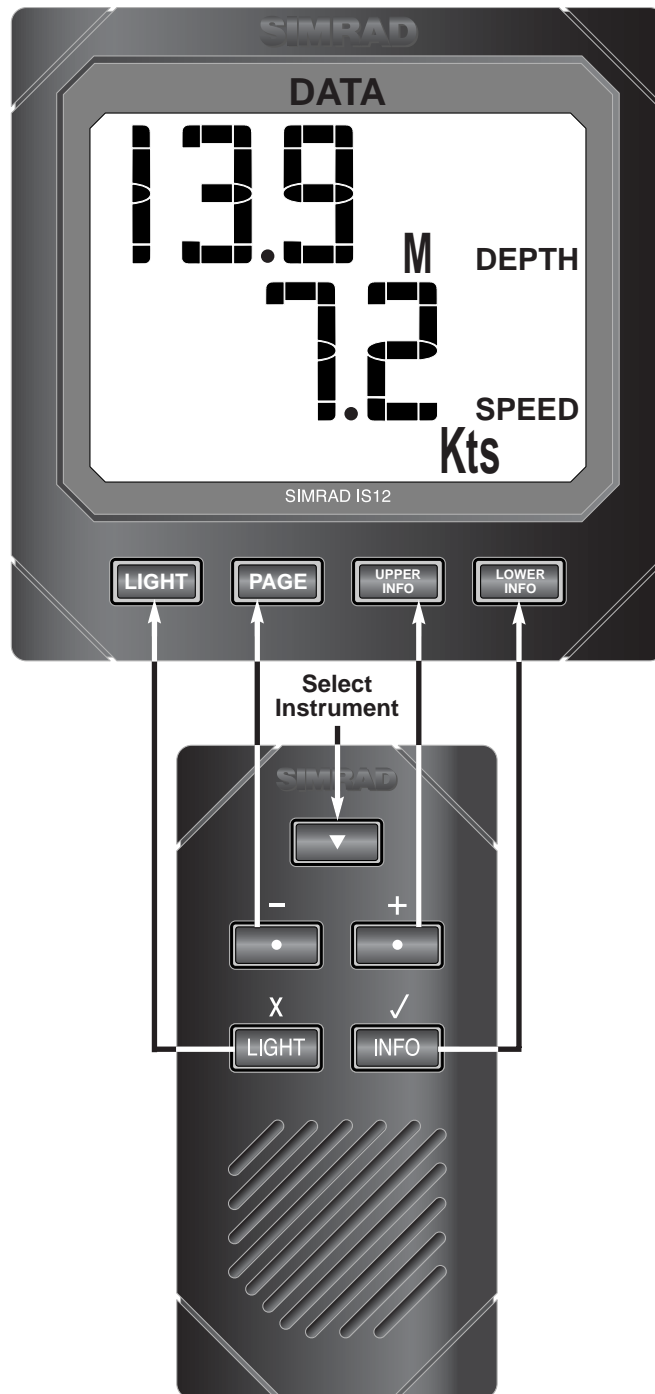

Fig 2.5 - Remote Control Key Positions

3 CALIBRATION

To protect the calibration functions, these are held in a hidden menu. To enter calibration mode, press and **hold** the **LIGHT** key (Fig 3.1) -

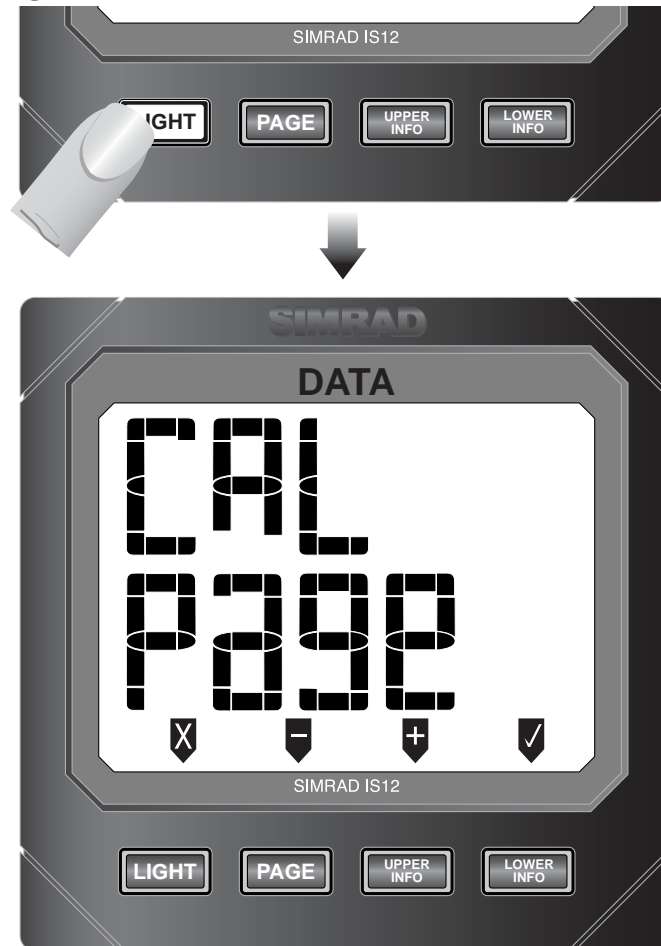

Fig 3.1 - Entering Calibration Mode

Once in calibration mode, pressing the **⏪** (**PAGE**) and **⏩** (**UPPER INFO**) keys will cycle through the available calibration options -

- Page Configuration (Section 3.1)
- Local / Network Backlighting (Section 3.2)
- Disabling Remote Control Facility (Section 3.3)

To exit calibration mode, press and hold **⏪** (**LIGHT**).

3.1 Page Configuration

Enter calibration mode and press **LOWER INFO** (✓) (LOWER INFO). The layout of the four Page displays can then be changed -

Press **PAGE** (☐) to cycle through the four pages and select the Page to be amended.

Press **LOWER INFO** (✓) to cycle through the available data on the bottom line of the display (Fig 3.2) -

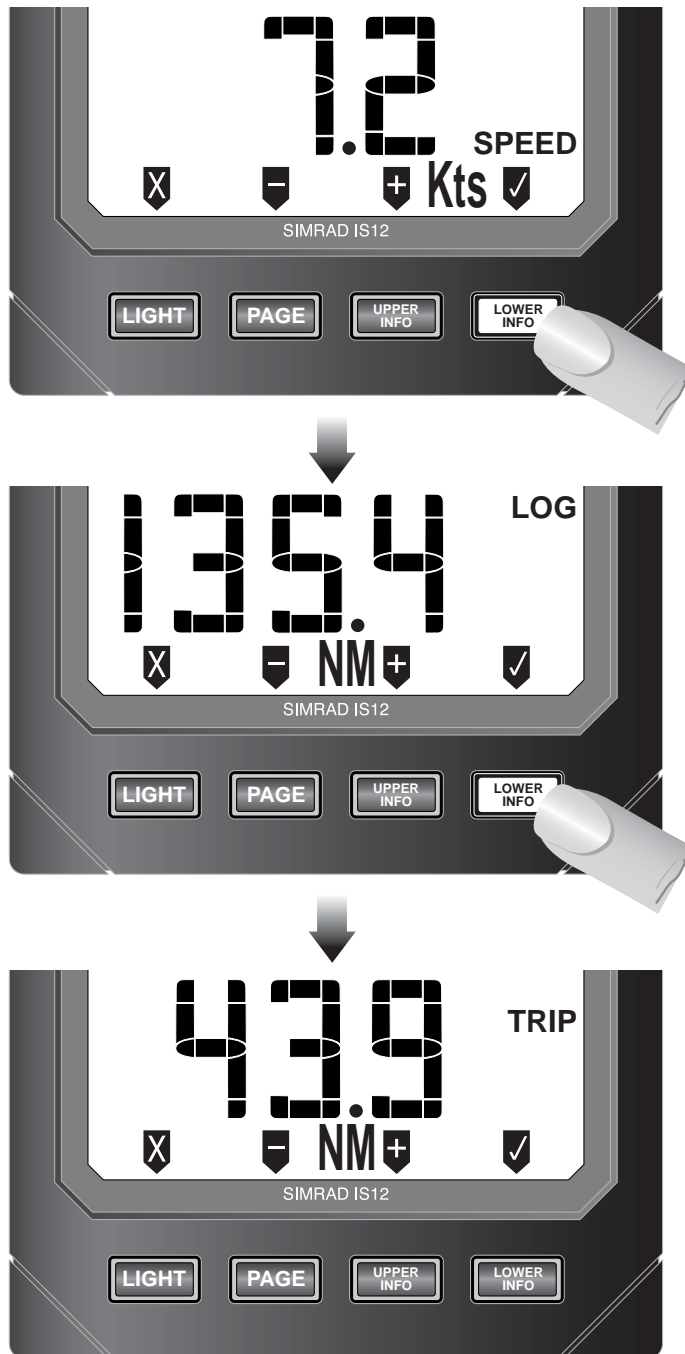

Fig 3.2 - Changing Page Layout

Press **UPPER INFO** (⏏) to cycle through the available data on the top line of the display.

NOTE

If a new data item is selected (i.e different from the original page setting) the digits will flash.

Press **PAGE** (⏏) to set the layout of Page 1 and move on to Page 2.

Repeat the procedure as described for each of the four Pages.

Upper Info Data Options -

- Depth ↵
- Shallow Alarm Setting ↵
- Deep Alarm Setting ↵
- Apparent Wind Angle ↵
- True Wind Angle ↵
- Compass Bearing ↵
- Bearing To Waypoint (BTW) ↵
- Course Over Ground (COG) ↵
- Lat/Long ↵

Lower Info Data Options -

- Boat Speed ↵
- Log ↵
- Trip ↵
- Water Temp ↵
- Average Speed ↵
- Max Speed ↵
- Race Countdown / Elapsed Timer ↵
- Apparent Wind Speed ↵
- True Wind Speed ↵
- Wind Speed Alarm Setting ↵
- Rudder Angle ↵
- Speed Over Ground (SOG) ↵
- Cross Track Error (XTE) ↵

Press **⏏** (**LIGHT**) to accept the changes and exit to the calibration menu.

NOTE

If selecting Lat and Long as a Page display (use the **Upper Info** key), this will fill both the top and bottom lines of the Page simultaneously.

3.2 Local & Network Backlighting

The backlighting can be set so that any changes made are duplicated across the system (*Network*), or so that any changes are limited to the specific instrument only (*Local*). The IS12 instruments are set to Networked lighting as default.

Enter calibration mode, press **⇩** once (the display will show CAL LIGHT) and press **✓** (**LOWER INFO**).

The top line will show the current setting - NET for Networked or LOC for Local. The setting can be changed using the **⇩** or **⇧** keys (Fig 3.3) -



Fig 3.3 - Changing from Network to Local Backlighting

To set the selected backlighting, press **✓**. The display will then return to the main calibration menu.

NOTE

Press **X** to exit to the main calibration menu at any point.

NOTE

Any changes will affect this specific instrument only.

3.3 Disable Remote Control

On some installations which includes the IS12 Remote Control, it may be more convenient to limit remote control access to only some instruments on the network - for example on a fly-bridge power boat with a set of instruments on both steering stations, it would not be desirable to be able to control the instruments on the flybridge (Fig 3.4) -

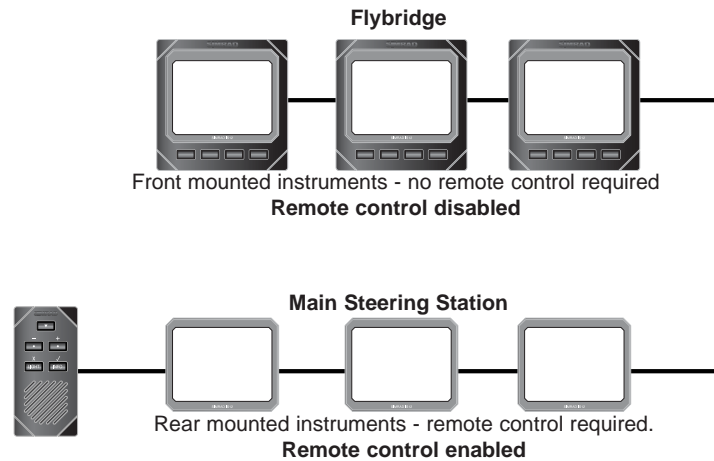

Fig 3.4 - Flybridge system with Remote control of main steering system only

To disable Remote control functionality on this instrument, enter calibration mode, press **+** twice (the display will show CAL CTRL) and press **↓** (**LOWER INFO**).

The large digits will show the current setting - ON for remote control enabled or OFF for remote control disabled. The setting can be changed using the **↓** or **↑** keys.

To set the selected mode, press **↓**. The display will then return to the main calibration menu.

NOTE Press **⏏** to exit to the main calibration menu at any point.

NOTE Any changes will affect this specific instrument only.

For further information on Remote Control operation, please refer to the user manual supplied with the Remote Control / Alarm unit.

4 INSTALLATION

4.1 Instrument Head Installation

All IS12 instrument heads are a standard 110 x 110mm (4.3x 4.3in) size, and can be mounted either from the front or the rear.

4.1.1 Front Mounting

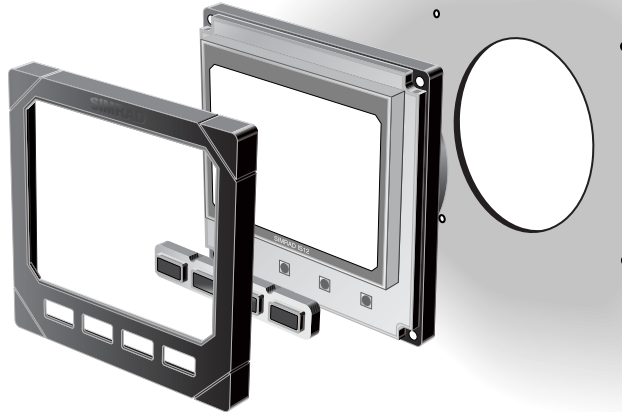

Fig 4.1 - Front Mounting



Fig 4.2 - Clearance Required Behind Bulkhead

Front mounting (Fig 4.1) is the standard method of fitting and is the most straightforward. When mounting the instrument head it is important to ensure that there is adequate clearance behind the bulkhead for the rear of the instrument with the cables inserted - allow at least 65mm (2.5 in) clearance (Fig 4.2).

Additionally, the instrument should not be fitted to a surface that has a curve greater than 1mm ($\frac{1}{5}$ in) across the mounting area. If fixing to an uneven surface, care should be taken not to overtighten the screws. When choosing a location, consideration should be given to the water integrity of the gasket seal if the surface is not flat. IS12 is designed to be weatherproof, but the rear of the instrument case with its electrical connections should be protected from moisture as far as possible.

Tools required for installation -

- Drill
- 85mm (3.4in) hole saw
- 2.5mm (0.09in) drill bit
- Countersinking bit

Using the self adhesive template supplied, drill the central aperture for the instrument case using the hole saw, then the four fixing holes as indicated on the template. If the instruments are to be fixed to a GRP bulkhead, the fixing holes should be countersunk after drilling, to stop the screws splitting the gelcoat.

ctd -

The instrument is 110mm (4.33 in) square, but a distance of at least 6mm (0.25 in) should be allowed between adjacent units for the protective instrument cover supplied.

NOTE

Long term exposure to direct sunlight can damage the liquid crystal display if left unprotected when not in use - always use the instrument cover supplied.

The easiest way to fit the keypad and the bezel to the installed instrument head is to locate the keypad in the keyholes in the bezel and then offer this up to the instrument head, angling the bezel back slightly to prevent the keypad falling out. The bezel should click into place when located correctly (Fig 4.3) -

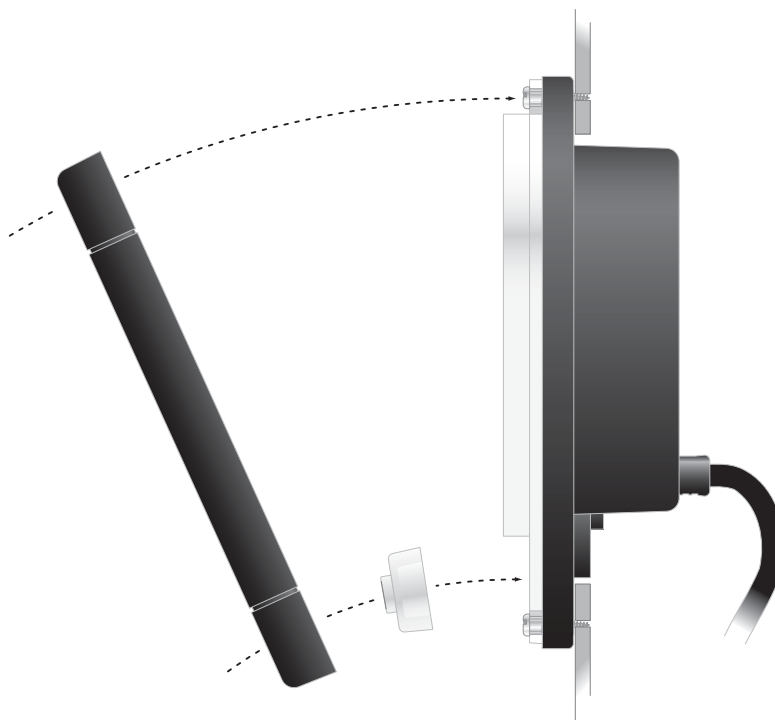

Fig 4.3 - Fitting Keypad and Bezel

To remove the bezel, simply lift the top edge of the bezel slightly to disengage the locking clips and pull away from the instrument head (Fig 4.4) -

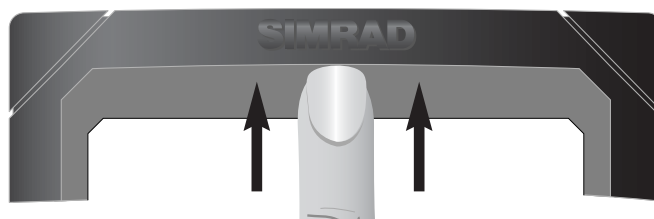

Fig 4.4 - Removing Bezel

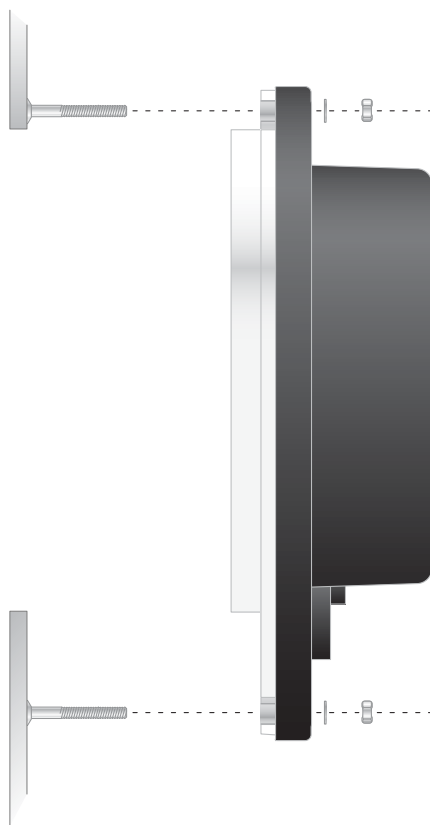

Fig 4.5 - Rear Mounting

4.1.2 Rear Mounting

When the instrument is rear mounted, only the display can be seen - the main body of the instrument, including the keypad is hidden behind the panel. This is a more elegant method of installation, but does require precise cutting of the apertures into the bulkhead or dashboard. **Therefore, it is recommended that installation is done by a professional marine installer.**

The instrument can be fixed to the panel using either the self tapping screws supplied (if the panel is thick enough), or using 2mm studs fixed to the rear of the panel which align with the four fixing holes (Fig 4.5).

Tools required for installation -

- Drill
- 5mm (0.2in) drill bit
- Fretsaw
- A fine toothed file.

To assist in cutting a precise aperture for the display, a self adhesive template is supplied with the unit (Fig 4.6) -

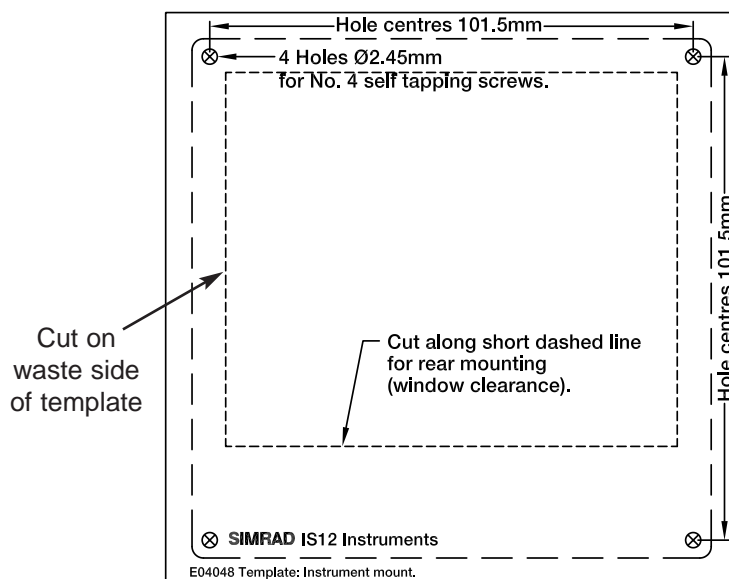

Fig 4.6 - Cutting Aperture

Fix the template in the correct position and drill four 5mm holes on the waste side of the four corners of the aperture. Starting from one of these holes, **carefully** cut along the dotted line around the four edges. To ensure the hole is a good fit, cut slightly inside the line (on the waste side) and then use the file to smooth the edges until the display fits precisely.

NOTE

Because the keypad is not accessible with this method of mounting, the Remote Control unit (see Section 2.9) will be required to enable control of instrument functions.

4.2 Electrical Installation

IS12 instruments are ‘daisy chained’ together, with each instrument linking to the previous one by a single cable carrying power and data (Fig 4.7). The cable plugs into either of the two circular network ports on the rear of the instrument.

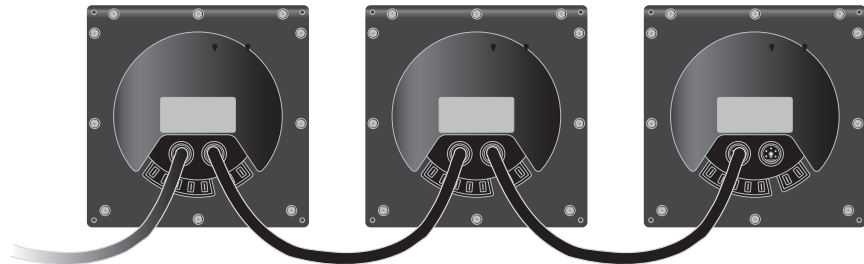

Fig 4.7 - IS12 “Daisychain” Cable System

The cable connectors are keyed so that they will always be correctly oriented when inserting the cable into the instrument - the flattened edge of the connector should be facing down when inserting (Fig 4.8) -

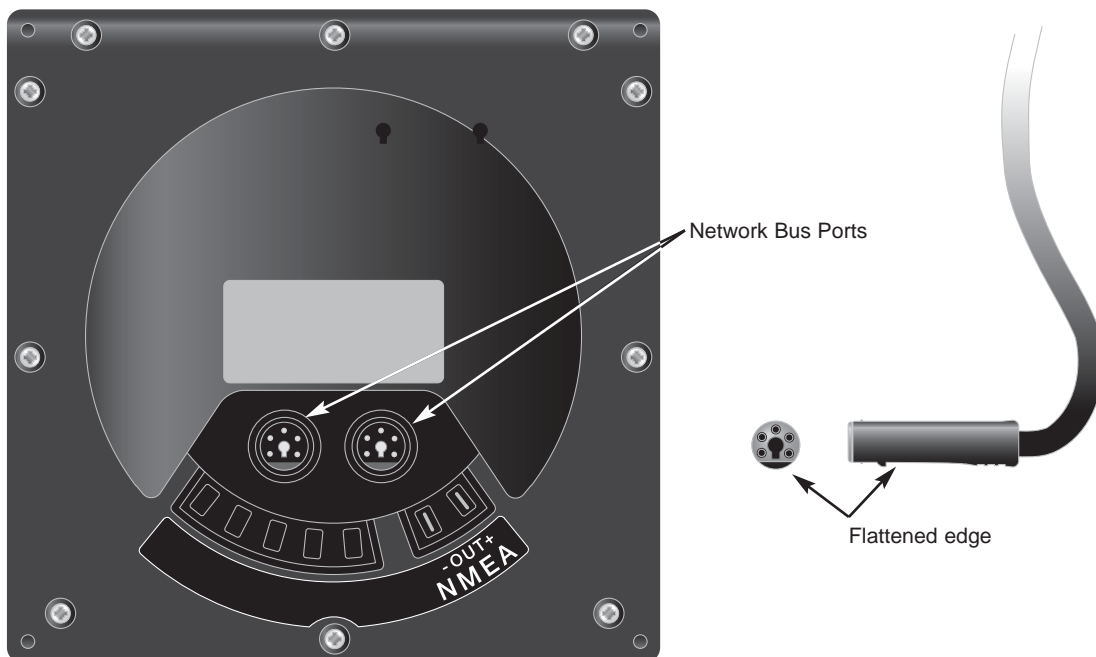

Fig 4.8 - Rear Connections

The network terminator (Fig 4.9) supplied should be fitted to a spare network port, unless the system already has a terminator fitted, or includes an IS12 Wind Transducer (which incorporates a terminator). *Only one network terminator is required per system.*



Fig 4.9 - Network Terminator

A three way joiner (part no. **SDJ**) is available as a separate accessory (Fig 4.10) -

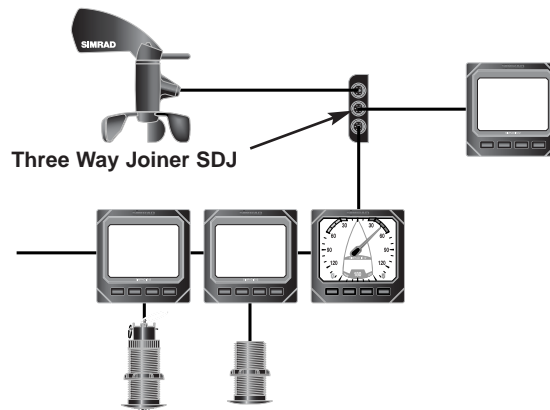

Fig 4.10 - Three way joiner

4.3 NMEA Output

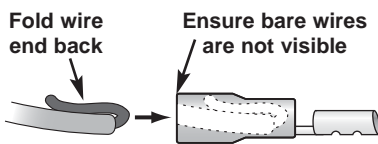

Fig 4.11 - Crimp Terminals

The Data instrument features an NMEA0183 output - the Data instrument is interfaced to external equipment using the crimp terminals supplied. To ensure a good connection when fitting the terminals to the interface cable, fold back the exposed wires over the insulation before inserting into the terminal (Fig 4.11). Use a good quality crimp tool to crimp the terminals.

The two terminals on the rear of the unit (Fig 4.12) are marked NMEA OUT + (Data) and NMEA OUT - (Common). These should be connected to the NMEA IN connections of the interfaced equipment.

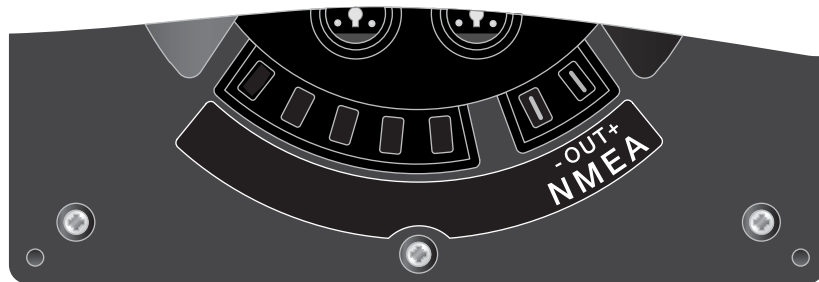

Fig 4.12 - NMEA Connections

The following data sentences are output by the Data unit -

DBT	Depth below transducer
DPT	Depth below transducer & offset
HDG	Magnetic Heading inc Deviation & Variation
MTW	Water Temperature, °C
MWV	Wind Speed & Angle
VHW	Boat Speed & Magnetic Heading

NOTE

The above NMEA sentences will only be outputted if the relevant master unit is present on the IS12 system, i.e the Wind Transducer must be present for the Wind sentences to be generated.

5 APPENDIX

5.1 Fault Finding

Symptom	Possible Cause	Remedy
No display on any heads in the system	<ul style="list-style-type: none"> Faulty connection to power Fuse has blown 	<ul style="list-style-type: none"> Check power connection Replace fuse and check power supply current
No display on one or more heads in system	<ul style="list-style-type: none"> IS12 data cable loose or broken 	<ul style="list-style-type: none"> Check cable linked to first faulty unit. Replace if necessary
Occasional poor performance	<ul style="list-style-type: none"> Electrical interference from other equipment on boat 	<ul style="list-style-type: none"> Fit interference suppressors to equipment responsible
Display shows “---”	<ul style="list-style-type: none"> Master unit not present in system Faulty connection to master unit 	<ul style="list-style-type: none"> Data can only repeat data that is available on network Check data cable links
No NMEA Output	<ul style="list-style-type: none"> NMEA connections reversed 	<ul style="list-style-type: none"> Check NMEA connections

These simple checks should be carried out before seeking technical assistance and may save time and expense. Before contacting your servicing agent please note the unit's serial number.

5.2 Spares & Accessories

The following spares and accessories are available from local Simrad agents. Please quote part number when ordering -

IS12Data:R	Extra Data Repeater Display
IS12Mega:R	Digital Repeater (large digits)
IS12Remote:F	Remote Controller
SPC2M	Power Cable 2m
SDC0.3M	IS12 Cable 0.3m
SDC02M	IS12 Cable 2m
SDC05M	IS12 Cable 5m
SDC10M	IS12 Cable 10m
SDJ	Three Way Cable Joiner
STP	Spare Network Terminator
PIC	Spare Instrument Cover
ISPK05	Spare Bezel & Keypad Pack - Data

5.3 Dimensions

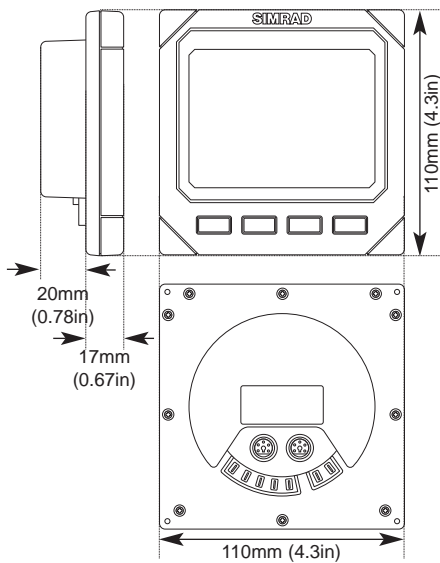

5.4 Specification

Supply Voltage	12v (9-16v) DC
Current Consumption	Light Off - 40mA Light On - 60mA
NMEA Output	DBT, DPT, HDG, MTW, MWV, VHW
Max units per system	32
Ambient Temp Range	-10°C to +55°C (14°F to 140°F)

5.5 Service & Warranty

Your equipment should seldom need servicing, although it will benefit from an application of silicone or Teflon grease to the contacts each season. The transducer should be removed and cleaned of fouling regularly, and we recommend it is removed and replaced with the bung supplied if the boat is to be laid up.

The unit is guaranteed for 2 years from date of retail sale. If it is necessary to have the unit repaired, return it carriage prepaid to the agent in the country of purchase with a copy of the receipted invoice showing the date of purchase. Where possible, return all the components unless you are certain that you have located the source of the fault. If the original box is not available, ensure that it is well cushioned in packing; the rigours of freight handling can be very different from the loads encountered in the marine environment for which the unit is designed.

For Worldwide Warranty details, please refer to the Warranty Card supplied with this unit.



www.simrad.com

ALWAYS AT THE FOREFRONT OF TECHNOLOGY

SIMRAD
A KONGSBERG Company