

**SIMRAD**

# Easy. Touch.

Simrad NSS Touchscreen Multifunction Displays

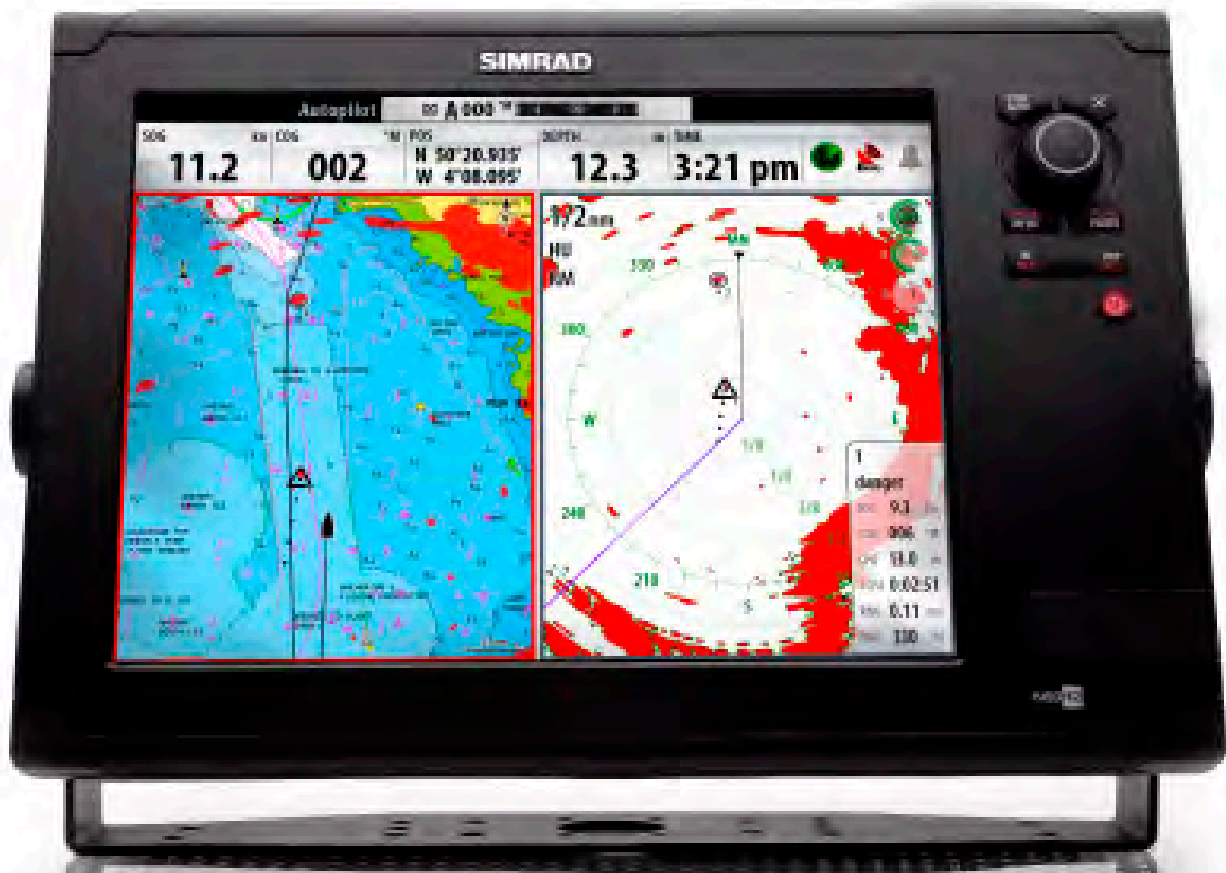

**NSS SPORT**

A **Touch** simpler.

New  
for 2011

# Introducing NSS.

## NSS SPORT

- ▶ Incorporating our outstanding Touch Sensible™ technology, the all-new NSS Sport is *the* touchscreen navigation system for recreational boaters. Available with bright, sleek, and stylish 6.4, 8, & 12.1 inch displays, the NSS Sport line is simple to use and easy to expand. Similar to NSE and NSO, the NSS range delivers 'best in class' charting, radar, and echosounder performance, as well as unique control and integration options.

**A Touch simpler.**



# ▶ We've worked hard to make Simrad an easy choice.

## ▶ Extreme Ease of Use

Simple menus and icons on the touchscreen guide you to the information you need, and the keypad includes 'one-touch' buttons for immediate access to important functions such as autopilot. It's easy to use for everyone onboard.

## ▶ Touch Sensible™ Technology

Developed specifically for the marine environment, Touch Sensible™ Technology is the combination of touchscreen, keypad, and smooth rotary controller. This perfect blend allows the NSS Sport to deliver unrivalled performance of every function with the simple touch of a finger in any sea state.

## ▶ Powerfully Fast Charting

The NSS Sport is a fast and efficient chartplotter. Panning the charts, marking waypoints, or building routes are easy on the touchscreen, whilst ultra-fast zooming is effortless with the smooth rotary controller.

## ▶ Expandable

The NSS Sport is 100% compatible and networks easily with every Simrad high performance module. It can also be integrated with NSE and NSO systems for the ultimate in flexibility.

## ▶ Full Control and Integration

Monitor your engine, steer your autopilot, turn on your bait well or bilge pump, even set mood lighting – it's all a touch simpler with the NSS Sport.

## ▶ Bright

Unique LED backlighting technology allows the NSS Sport display to be bright, clear, and highly visible in every conceivable condition. This technology also reduces power consumption and increases product life.



# Integrate everything

Innovative high-performance plug and play performance modules make Simrad Navigation Systems best in class, in every class.



## StructureScan™

Revolutionary StructureScan™ creates the ultimate in reality EchoSounding.

StructureScan™ provides wide coverage in high detail with SideScan and DownScan™ Imaging, providing picture perfect images of structure and fish directly below your boat for a true 180° view.

StructureScan™ high-speed ethernet networking allows more than one compatible Simrad display to share one StructureScan™ transducer that can be viewed on all NSO, NSE and NSS units; plug-and-play ethernet allows for quick, clean installation.



## High Speed GPS

The impressive 16-channel NMEA 2000 GPS antenna provides superior sensitivity for signal acquisition, with incredible position accuracy, in a compact size that is easily flush mounted. This advanced positioning antenna is compatible with NSO, NSE and NSS systems.

The NSS comes with a standard antenna built-in.



## SonicHub™

SonicHub™ integrates flawlessly with award winning Simrad NSO, NSE and NSS displays to make your music more accessible when on the water, with a direct link to your entire music collection via your iPhone, iTouch, iPod or USB device, without the need for a stereo head - Selecting and playing music couldn't be simpler.



## Broadband Sounder Modules

(Built-in BSM-1 with NSS7 & NSS8)

Raising the bar in fishfinding technology, Simrad Broadband Sounder Modules (BSM) deliver incredible echo clarity and the highest underwater definition ever achieved. Choose either BSM-1 or BSM-2, depending on your needs, for Best In Class performance.





## Digital Switching

Simrad Yachting breaks new ground with support for CZone digital switching from BEP Marine. CZone digital switching offers a new paradigm for cost effective control and monitoring of nearly any system on your boat. The Simrad NSE can operate as a CZone controller. Control your lights, turn on your bilge pump, monitor tank levels – all from your NSO, NSE or NSS navigation system. Simrad and CZone – a partnership in Innovation.

Find out more: [www.bepmarine.com](http://www.bepmarine.com) 



## Autopilot

The world's best performing autopilot system integrates with NSO, NSE and NSS. Engineered to benefit both "space-challenged" dash layouts and multi-station expanded systems like flybridge boats, NSO, NSE and NSS autopilot integration offers tremendous flexibility. Control your autopilot like never before from your large, brilliant primary display. Better yet, there is now the option of touchscreen control with the new NSS Sport.



## AIS

Integrate an NSO, NSE or NSS system with Simrad AI50 or NAIS-300 Class B AIS Systems to see and be seen. Overlay AIS-equipped vessel information on chart and radar displays for exceptional situational awareness.



Broadband Radar™

HD Digital Radar™



## Broadband Radar™

A revolution in radar unlike anything else on the recreational boating market, the Broadband Radar utilises solid-state technology and provides superior target detection and separation at closer ranges, ease of operation and a new level of navigational safety.



## HD Digital Radar

Simrad offers a range of radome and open array digital signal processing radar systems, working with power levels from 2 kW to 25 kW via high capacity Ethernet. These radars ensure exceptional detection of small or distant targets, virtually eliminating screen clutter allowing a clear and accurate image.

# True innovation

SIMRAD NSS

## StructureScan™

- View picture perfect images of structure and fish
- SideScan provides a top-down panoramic view on either side of the boat
- DownScan™ imaging gives a life-like representation of water structure
- Clearly separate fish targets from surrounding structure using DownScan Overlay

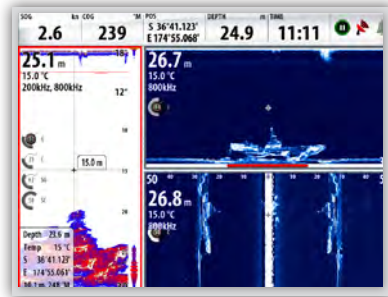

## Autopilot

- Fully control your Simrad Autopilot from any NSS or NSE display
- Alter course with the Rotary Controller or Cursor Pad (NSE)
- Dedicated Standby / Auto key and Pilot Status indicators allow safe, easy Pilot operation
- The NSS or NSE can replace or work together with an AP24 or AP28 controller
- Fully configure the Autopilot from your NSS, NSE or NSO display



▲ Combine charting, autopilot and vessel pages for unprecedented vessel control

## SonicHub™

- SonicHub™ integrates flawlessly with NSS, NSE and NSO systems
- The direct link to your entire music collection at the touch of a button
- Multi-zone technology gives you total control over the music playing in all areas of your boat
- Docking station specifically designed to protect your iPhone, iPod or USB device in the challenging marine environment
- Catch the latest weather forecast or listen to your favourite radio show

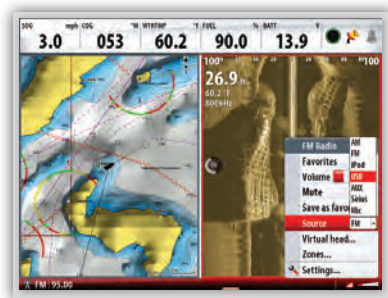

Made for  
iPod iPhone

▲ Exclusive waterproof marine on-board AV entertainment system with multi-display control access, flawless network system integration and boat-wide, multi-zone technology.

## Broadband Radar™

- Crystal clear image
- InstantOn™
- Low power consumption
- Extremely low emissions
- Quick installation
- Automatic clarity

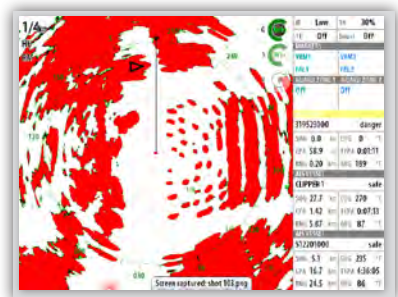
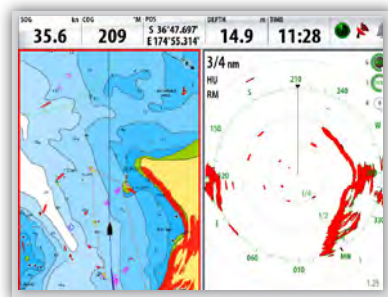

# A touch simpler.

“Charting, radar, echo, and complete boat control - all a touch simpler with Touch Sensible™ technology.”

▶ PRODUCT LINE DIRECTOR, MIKE FARGO



▲ Clear, concise menus enable easy orientation and fine adjustment of each page.



▲ Simple icons provide instant access to the functions you require.



▲ Drag and drop pages to set up custom screens in seconds with Touch Sensible™ technology.

▶ **Autopilot LEDs:**



Get general steering confirmation at a glance. Surrounding the rotary controller are port and starboard LED's that indicate course adjustments.

▶ **Built-in Broadband Sounder for NSS7 & NSS8:**



Find more fish and improve your view with high definition echo clarity as standard.

▶ **Built-in GPS:**



Integrated GPS antenna for incredible position accuracy.

▶ **Micro SD Charts:**



Switching charts in seconds has never been so simple.

▶ **Rotary controller:**



Perfectly intuitive for fine or course control of gain, zoom and menu with push to enter functionality

▶ **IPX7 Waterproofing:**



Elegant yet rugged, and totally waterproof.

▶ **Touch Sensible™ Technology:**



The perfect combination of touchscreen, keypad, and super-smooth rotary controller.



# Extended Family

## ► NSO Offshore, NSE Expert and NSS Sport systems

Operate on the same network and use the same control interface. Mix and match displays to accommodate nearly any helm requirement. Select the display that fits, then build your system with Simrad Performance Modules. It's that simple.

NSO OFFSHORE ▼

NSE EXPERT ►

NSS SPORT ▼



Simrad Yachting is pleased to announce our new extended family of networked navigation systems. The new NSS Sport range provides boaters with the ultimate Touch Sensible™ technology for total control with an easy to use interface. The NSO Offshore and the NSE Expert systems both operate on the same network as the NSS Sport, so you can mix and match displays to accommodate nearly any helm requirement. Simrad displays are now available from 6.4 inches to 19 inches.



#### NSO OFFSHORE

- ▶ With sleek and stylish 10, 15 & 19 inch displays the NSO Offshore line - for vessels with larger helm displays - is versatile and easy to expand. Based on the Simrad NSE platform, the NSO delivers 'best in class' charting, sounder, and radar performance as well as unique control and integration options.

#### NSE EXPERT

- ▶ Easy-to-use, bright visible displays with uncluttered presentation. The Simrad NSE 8 and 12 inch multifunctional displays provide professional level performance with sophisticated charting, radar and echo sounder integration. With powerful networking and vessel integration capabilities, NSE provides comfort and control at sea.

#### NSS SPORT

AVAILABLE MAY/ 2011

- ▶ With its Touch Sensible™ technology, the all-new Simrad NSS Sport is extremely simple to operate. The bright and stylish 6.4, 8 or 12.1 inch displays make them the perfect partner for every recreational boater. And with full networking capabilities, they offer effortless performance and integration.

# Suggested Systems

## Single Display

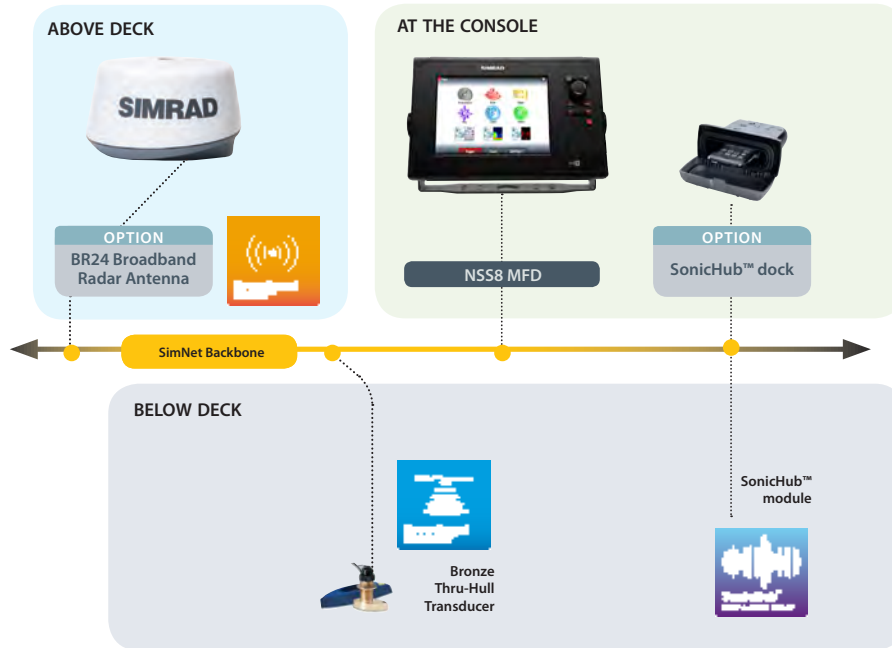

## Dual Display

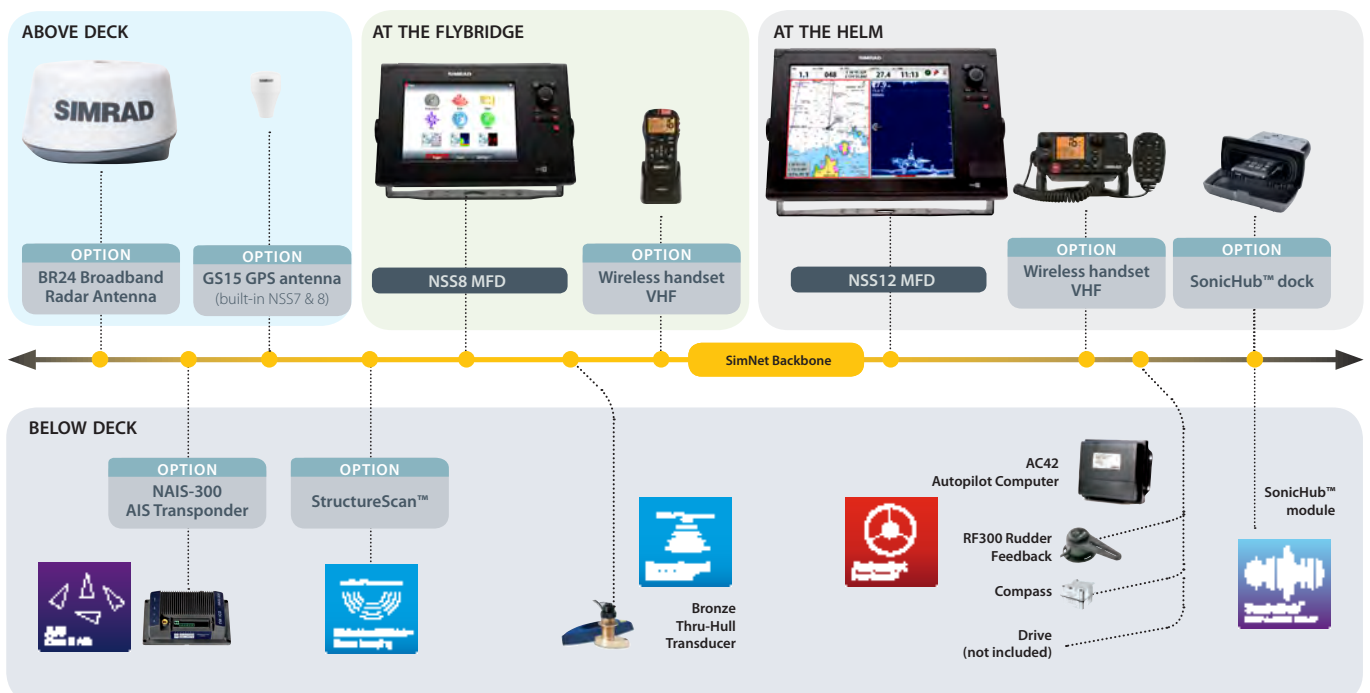

# Dimensions

## NSS7

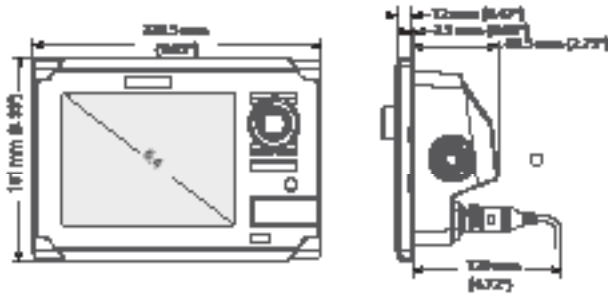

## NSS8

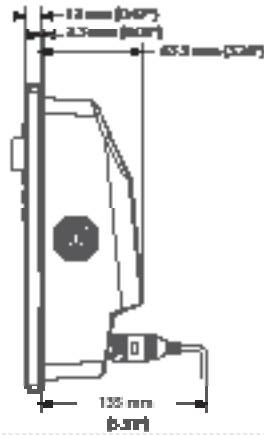
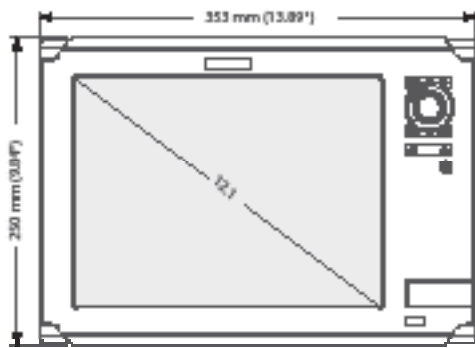
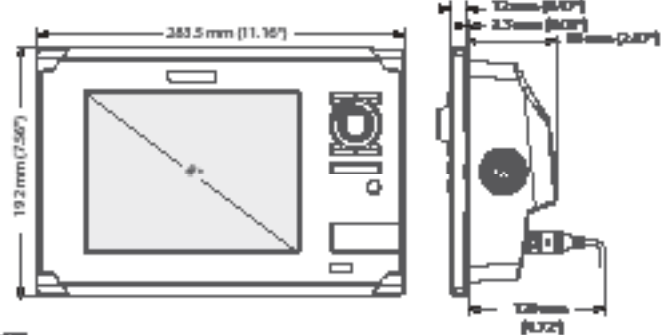

SPECIFICATIONS

# Specifications

## NSS Specifications

	NSS7	NSS8	NSS12
<b>Display</b>			
Type	6.4 inch VGA Color TFT LCD	8 inch SVGA Color TFT LCD	12 inch XGA Color TFT LCD
Screen Resolution	480 x 640 (H x W)	800 x 600 (H x W)	1024 x 768 (H x W)
Screen Brightness	1200 nits	1200 nits	1200 nits
Touchscreen	YES	YES	YES
Weight (Head unit only)	1.6kg / 3.5lb	2.1kg/ 4.6lb	3.78 kg/ 8.3 Lbs
<b>Mechanical</b>			
Housing Construction	Plastic housing; Die Cast Rear Heatsink		
<b>Echosounder (Sonar)</b>			
Sonar Frequency	50/200 or 83/200 kHz	50/200 or 83/200 kHz	Not Applicable
Sonar Output Power	Max 250W Peak to Peak (31W RMS) actual	Max 250W Peak to Peak (31W RMS) actual	Not Applicable
Sonar Depth	Max 3000 ft \ 1000 m	Max 3000 ft \ 1000 m	Not Applicable
<b>interface</b>			
Ethernet	1 Port	1 Port	3 Port
Interface (NMEA 2000)	Micro C (1)		
Video Input	Composite Video x (2) (multiplexed)		
SD Card Slot	Micro SD (1)		
<b>Environment</b>			
Temperature	-15 Deg C to +55 Deg C (+5 Deg F to +131 Deg F)		
Waterproofing	IPx7		
<b>Power</b>			
Power supply	12.0 V DC-24.0 V DC (9.0 - 32.0 V DC Min-Max)		
Power consumption	10.4W or 0.8A @ 13VDC	15.6W or 1.2A @ 13VDC	26W or 2.0A @ 13VDC
Certificates of Conformity	CE(EN60945:2002)/Ctick/CCS		



Your gateway to  
[Simrad-Yachting.com](https://www.simrad-yachting.com)

**SIMRAD**

[www.simrad-yachting.com](https://www.simrad-yachting.com)